

Hawkins®

PRESSURE COOKER

Instruction Manual with Tested Recipes,
List of Service Centres
and Guarantee Card

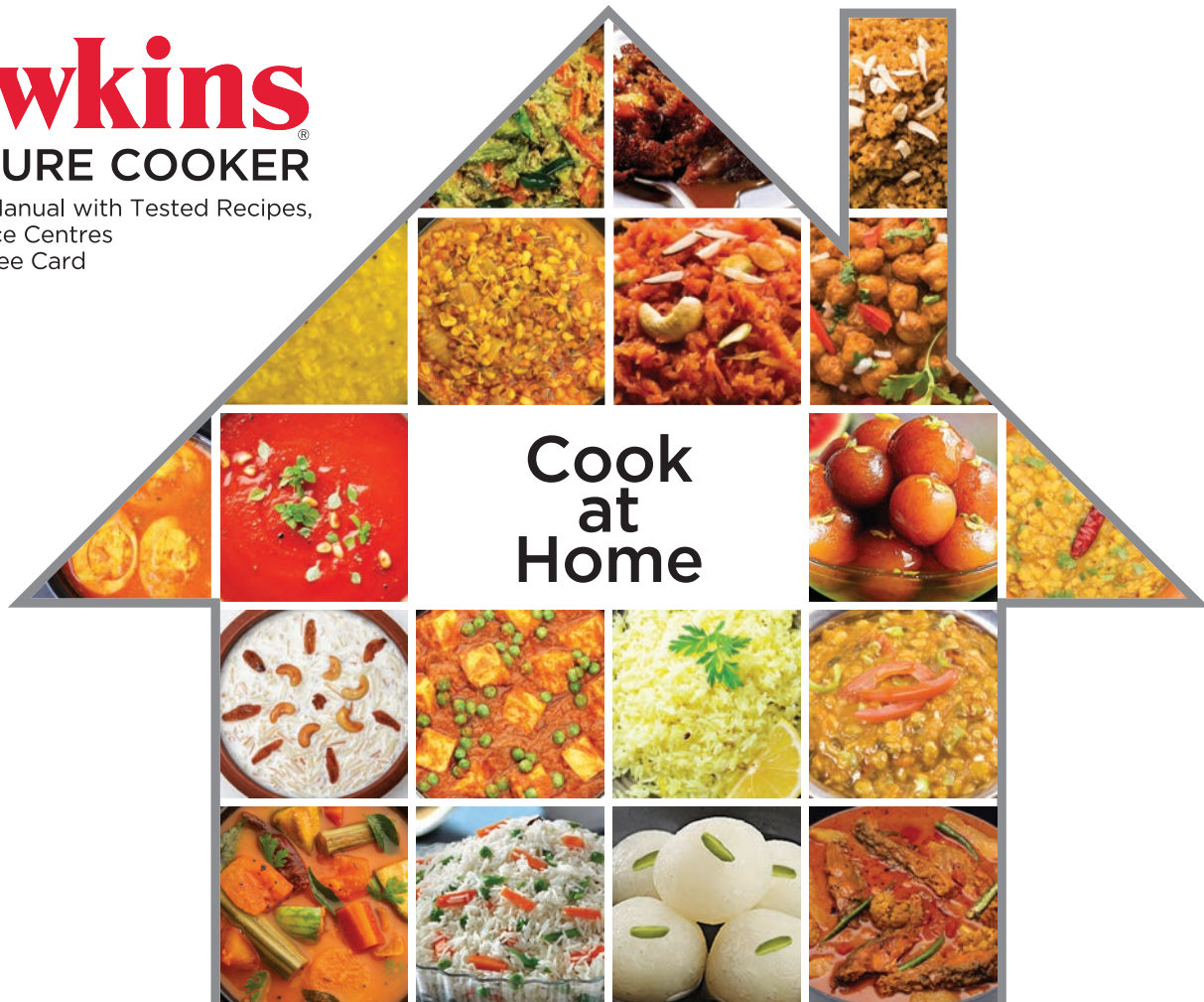

For You A personal message

Thank you so much for buying a Hawkins product. We at Hawkins take all efforts to ensure that you have a good experience while using our products. Reading these instructions will help you understand what the products can do and what they cannot do, thus giving you the best results.

Your trust is very precious to us. The same thought and care that has gone into the design and manufacture of the Hawkins Pressure Cooker has gone into writing these instructions.

This pressure cooker will save you around 50% time and fuel, will cook hygienic and healthful food and give you trouble-free service for years. It is an extremely energy-efficient method of cooking. Home-cooked, healthful food is the best gift you can give your friends, your family and yourself.

This cookbook contains four recipes each from the North, South, East and West of India. This pressure cooker can be used to cook many more recipes. Check them out at www.hawkins.in/recipes.

We have sold over 100 million products in more than 60 countries over the last 60 years. We make and sell pressure cookers of all shapes and sizes and cookware like Tavas, Frying Pans, Deep-Fry Pans and Cook-n-Serve Bowls.

Hawkins, since its very beginning, has been very careful to put the consumer at the heart of its business. The culture of the Company has been to design keeping the consumer in mind, use the best available materials, conduct rigorous quality checks, package the product carefully, and give proper instructions and good service. The overarching focus on the consumer has determined the type of products we

produce, the type of people we select and promote, and the level of service that we provide.

It is keeping this culture in mind that I write this message to all of you, who use our products. If you face any problems or have any suggestions, write to me. I assure you that we will listen.

I very much hope that you enjoy using our products.



Subhadip Dutta Choudhury

Subhadip Dutta Choudhury
Chairman & Chief Executive Officer
Hawkins Cookers Limited
F 101, Maker Tower, Cuffe Parade, Mumbai 400 005
chairman@hawkinscookers.com



HAWKINS PRESSURE COOKER INSTRUCTION MANUAL WITH TESTED RECIPES

For

- Hawkins Classic
- Hawkins Contura
- Hawkins Contura Black
- Ceramic-Coated Hawkins Contura

Pressure Cookers

Hawkins and Contura are Registered Trademarks of Hawkins Cookers Limited in India and in various other countries throughout the world. Hawkins Cookers Limited is also the registered proprietor of Mustard Yellow Hawkins Contura, Tomato Red Hawkins Contura, Apple Green Hawkins Contura and Hawkins Contura Black trademarks. ©2022 reserved in respect of logos, pictures, text, layout, design and recipes in this Manual. All Rights Reserved. IM 62.

Manufactured by: Hawkins Cookers Limited, Maker Tower F 101, Cuffe Parade, Mumbai 400 005, India. Corporate Identity Number: L28997MH1959PLC011304

For any help, contact:

Hawkins Cookers Limited, New Udyog Mandir 2,
Pitamber Lane, Mumbai 400 016, India.

Tel: (91 22) 2444 0807

Fax: (91 22) 2444 9152

Email: kitchen@hawkins.in

Website: www.hawkins.in

IMPORTANT SAFEGUARDS

1. Read all instructions before use.
2. Do not touch hot surfaces. Use handles.
3. Close supervision is necessary when the pressure cooker is used near children.
4. Do not place the pressure cooker in a heated oven.
5. Do not wash in a dishwasher.
6. Extreme caution must be used when moving a pressure cooker containing hot liquids.
7. Do not use the pressure cooker for other than its intended use.
8. This appliance cooks under pressure. Improper use may result in scalding injury. Make certain unit is properly closed before operating.

See "Operating Instructions" i.e. "How to Close and Open the Hawkins" on page 12.

9. Always check that the pressure release devices (vent tube, vent weight and safety valve) are clear (free of clogging) immediately before closing the lid for pressure cooking.

10. Never place anything over the vent weight while cooking.

11. When starting to pressure cook, close the lid WITHOUT the pressure regulating device (vent weight) in position on the vent tube. Place the vent weight on the vent tube ONLY AFTER steam starts to come out of the vent tube steadily. See "Operating Instructions" i.e. "Trial Run" on page 15.

12. Always place water as indicated

in each recipe in the pressure cooker body before pressure cooking. As a general rule, when using pressure cookers of 1.5 Litre to 3 Litre capacity, place a minimum of one cup/240 ml water for the first 10 minutes of pressure cooking time plus a half cup/120 ml for every subsequent 10 minutes or part thereof. When using pressure cookers of 3.5 Litre to 6 Litre capacity, place a minimum of one and a half cups/360 ml water for the first 10 minutes of pressure cooking time plus a half cup/120 ml for every subsequent 10 minutes or part thereof. When using pressure cookers of 6.5 Litre to 12 Litre capacity, place a minimum of two cups/480 ml water for the first 10 minutes of pressure cooking time plus a half cup /120 ml for every subsequent 10 minutes or part thereof.

13. Do not fill the unit over $\frac{2}{3}$ full. When cooking foods that expand during cooking such as rice or dried vegetables, do not fill the unit over $\frac{1}{2}$ full. When cooking *dal*/pulses which sprout, never fill the cooker more than $\frac{1}{3}$ full. Overfilling may cause a risk of clogging the vent tube and developing excess pressure. See "Food Preparation" i.e. "Operating Instructions" on page 9.

14. Be aware that certain foods, such as applesauce, cranberries, pearl barley, oatmeal or other cereals, split peas, noodles, macaroni, rhubarb, or spaghetti can foam, froth and sputter, and clog the pressure release device (vent tube). These foods should not be cooked in a pressure cooker.

15. When the normal operating pressure is reached, turn the heat down so all the liquid, which creates the steam, does not evaporate.

16. Never attempt to force open the pressure cooker. Do not open the pressure cooker until the unit has cooled and internal pressure has been reduced. If the handles of the body and lid are difficult to push apart, this indicates that the cooker is still pressurised – do not force it open. Any pressure in the cooker can be hazardous. See "Operating Instructions" i.e. "Cooking Tips" on pages 21 and 22, "Releasing Pressure".

17. Never lift vent weight for reducing pressure in the case of liquid or frothing foods.

18. Do not use the pressure cooker for pressure frying with oil.

19. Never use the cooker body for light frying more than 20 minutes at a time or for deep frying or as an oven for dry heating or baking, since the strength of the metal may decrease to a dangerous level.

20. Ensure handles are not loose. If found loose, please tighten the same before use. (This does not refer to the "play" on the Hawkins lid handle bar, see "Product Information" on page 11.)

21. A fused safety valve must be replaced by a genuine Hawkins safety valve. It is recommended to replace the safety valve after one year of everyday use.

22. Repairs other than the replacement of gasket, body handle, safety valve and the vent weight must be done only by an authorised service centre/representative. All replacement parts must be genuine Hawkins parts.

**SAVE THESE
INSTRUCTIONS.**

CONTENTS

	PAGE		PAGE		PAGE
IMPORTANT SAFEGUARDS	2	PRESSURE COOKING CHARTS	42	Eastern Indian Recipes	68
OPERATING INSTRUCTIONS	5	Rice	42	<i>Chola Dal</i>	68
Useful General Information	5	<i>Dal</i>	45	<i>Illish Sarse Bata</i>	69
Product Information:		Legumes	48	<i>Khichuri</i>	70
Identify Your Cooker	7	Vegetables	51	<i>Aloor Dum</i>	71
Getting to Know Your Hawkins	8	Seafood	53	<i>Rasogolla</i>	72
Parts of the Hawkins Pressure Cooker	8	Meat and Poultry	54	Western Indian Recipes	74
How to Close and Open the Hawkins	12	RECIPES	55	Mixed Vegetable Pulao	74
Trial Run	15	Adjusting Recipes	55	<i>Tuvar Dal</i>	75
Cooking Tips	18	North Indian Recipes	58	<i>Vatanyachi Usal</i>	76
Using Grids, Separator Sets, Idli Stands and Molds	24	<i>Ma ki Dal</i>	58	<i>Murghi ma Kaju</i>	77
Care and Cleaning	31	<i>Matar Paneer</i>	59	<i>Lapsi</i>	78
What to Do if This Happens...	35	<i>Chana Pindi</i>	60	Glossary (Meanings and Methods)	79
Measurements	40	<i>Rajma</i>	61	PARTS, DO-IT-YOURSELF REPAIRS AND SERVICE	84
Maximum Cooking Capacities/ Volumes for Different Sizes of Hawkins	41	<i>Gajar ka Halwa</i>	62	Parts	84
Choose the Cooker Size to Suit Your Needs	41	South Indian Recipes	63	Do-it-Yourself Repairs	85
		<i>Kozhi Koottaan</i>	63	Service	88
		<i>Sambar</i>	64	Directory of Hawkins Authorised Service Centres	89
		<i>Elumichham Pazham Saadham</i>	65	INDEX OF RECIPES	99
		<i>Mansam Chops</i>	66	GUARANTEE CARD	Back Cover
		<i>Avial</i>	67		

OPERATING INSTRUCTIONS

Useful General Information

What is Pressure Cooking?

Ordinary, open-pot cooking usually happens at the boiling point of water which produces steam at sea level at 100°C. Pressure cooking works by sealing the steam in a pot so that there is a rise in pressure to a safe, controlled extent which raises the boiling point of water and therefore the cooking temperature. The Hawkins Pressure Cooker cooks food at 121°C at a pressure of 1 kgf/cm² or about 15 pounds per square inch (psi). The steam permeates through the food, tenderising it, bringing out its flavour, cooking much faster, better and preserving nutrients, colour, texture and juices.

Benefits of Hawkins Pressure Cooking

Hawkins pressure cooking can reduce normal cooking times by as much as half. Foods which take a long time to cook such as some legumes (*dal*, pulses, dried peas and beans) and tough cuts of meat can be cooked to perfection in a fraction of the normal time. Because food cooks faster in a pressure cooker, you save time, fuel, and therefore money.

Scientific literature indicates that certain nutritive elements such as proteins and vitamins are better retained by pressure cooking.

Steaming is ideal for low-calorie, low-fat cooking. The higher temperature while pressure cooking gives more hygienic food. Closed cooking in steam under pressure may better evoke the natural flavours of the food – producing delicious results. A wide range of foods, whether parts of recipes or entire meals, can be cooked in your Hawkins.

Advantages of Hawkins

Safe

- **Pressure-locked Safety Lid.** When there is pressure inside the cooker, the inside-fitting lid is pressure-locked like a modern jetliner door. It cannot be opened until the pressure has fallen to a safe level.
- **Automatic Safety Valve** is positioned such that, if it operates, the steam and food are deflected safely downwards.

Efficient Pressure Regulation

- **Vent Weight/Pressure Regulator** is designed to cook fast, regulate pressure efficiently, insert and remove easily and reduce sprouting.

Trouble-Free

- **Durable Construction.**

The Hawkins cookers are made from commercially pure, virgin aluminium, 3.25 mm/4.06 mm thick.

The Hawkins Contura Black has a hard anodised body and a stainless steel lid.

The Ceramic-Coated Hawkins Contura has a high-quality, scratch- and stain-resistant ceramic coating on the exterior and the base and a stainless steel lid.

- **Longer Lasting Rubber Gasket/Sealing Ring.** As the lid fits from inside, the gasket does not get rubbed sideways every time the pressure cooker is opened or closed. Also, the gasket is protected by the lid curl in which it sits as the gasket is not exposed to food acids in the pressure cooker due to protection given to it by the rim of the lid.
- **Rust Proof Components.** These Hawkins cookers have a steel or aluminium handle bar and bracket(s) to withstand rust.

Wide Range of Pressure Cookers

Hawkins, Futura and Miss Mary Pressure Cookers are currently available in 91 models and 19 sizes from 1.5 Litre to 22 Litre.

The Hawkins Test Kitchen

We have a Test Kitchen where products are tested, new recipes are developed, old recipes are improved and customer problems are addressed. For suggestions and queries on recipes or pressure cooking, write to us at: Test Kitchen, Hawkins Cookers Limited, Udyog Mandir 2, Pitamber Lane, Mahim, Mumbai 400 016. Email: kitchen@hawkins.in

Using Your Own Recipes

We recommend the recipes we have actually tested and included in this Manual. Once you are familiar with cooking with your Hawkins Pressure Cooker, you may adapt recipes from other cookbooks or use your own, making sure that you adjust cooking time, food and water quantities as may be needed (see **Cooking Tips**, pages 18–23).

DO NOT ATTEMPT TO COOK IN THE HAWKINS WITHOUT FIRST READING CAREFULLY THE REMAINING INSTRUCTIONS. ●

Product Information: Identify Your Cooker

This Manual is written for four models of Hawkins Pressure Cookers – **Hawkins Classic**, **Hawkins Contura**, **Hawkins Contura Black** and **Ceramic-Coated Hawkins Contura**. All the instructions in this Manual apply to all four models unless specific instructions are given for a particular model and size. Photographs of the four

models are given below. Identify your cooker, its name and its size (stamped on base) to help you find the instructions specific to your cooker throughout this Manual. The Hawkins Classic is depicted in the photographs used in the instructions but the functions and methods demonstrated apply to all four models.



Getting to Know Your Hawkins

Illustrated instructions on **how to close and open the Hawkins** are given on pages 12 and 13.

The cooker body comes fitted with a plastic **body handle** screwed on to a **metal handle bracket** attached to the cooker body. There is a **subsidiary body handle** attached to the cooker body in all models of 4 Litre capacity and larger, which helps carry the cooker when it is loaded.

The stated volume of all pressure cookers is with the lid closed. **Cooking capacity** in a pressure cooker is less than its full volume. The pressure **cooker body** should never be filled more than two-thirds its capacity. This is to safeguard against blocking the vent tube and to leave enough space to allow steam to circulate to cook the food.



Food Preparation: Certain foods – liquid foods such as soups and foods such as lentils, pulses, beans and rice which expand during cooking and/or froth – should not be filled more than half the capacity of the cooker body (all ingredients, food and water combined).

Any food which froths excessively and sprouts out of the cooker – such as *moong dal*, *urad dal*, *tuvar dal* and soybeans – should not be filled more than one-third the capacity of the cooker; if sprouting still occurs, reduce quantity further suitably until sprouting stops. We do not recommend cooking *moong dal* or *urad dal* in 3 Litre and smaller size cookers. The volumes of the two-thirds, half and one-third capacities for each size of Hawkins are given in **Maximum Cooking Capacities and Volumes for Different Sizes of Hawkins** on page 41.

The **lid** comes assembled with the detachable rubber **gasket**. It can be removed from the **lid curl** with your fingers. The gasket can be easily put back by slipping the **lid handle** through the gasket and patting and pushing it down all along the lid curl until it is seated properly. See how it is done in the pictures in the next column.

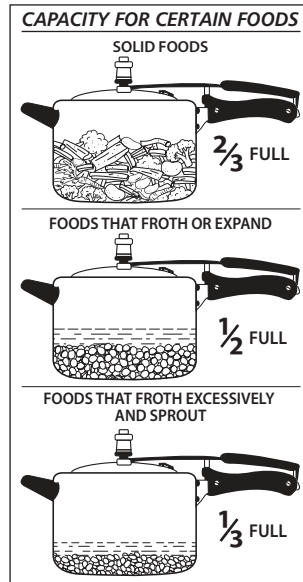

The cross section of the gasket for the 8 Litre (Wide), 10 Litre and 12 Litre Classic is not round like the cross section of the gasket for the 8 Litre Tall Classic, 6.5 Litre or smaller capacity. The cross section of the gasket for the 8 Litre (Wide) to 12 Litre pressure cookers has a round bottom and a slightly flattened top as is shown below.

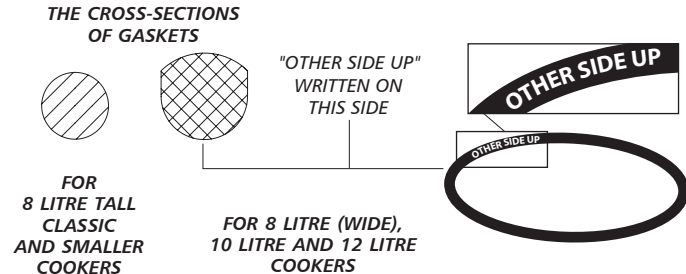

In the 8 Litre (Wide), 10 Litre and 12 Litre Classic, the gasket is marked "OTHER SIDE UP" on the round side which has to be placed at the bottom on the lid curl. For proper sealing, the slightly flattened side of the gasket should face up.

The **vent weight** automatically maintains the cooking pressure of 1 kgf/cm² or about 15 pounds per square inch. The vent weight has to be placed on the **vent tube** and pressed into position. When the vent weight is pressed down on the vent tube, there is a slight click which indicates the vent weight is in the correct position.



The vent weight has a spring mechanism which holds the vent weight on to the vent tube and is strong enough to prevent it from falling off should the lid be inverted.



The vent tube seats the vent weight and is the outlet for excess steam. The vent tube is also the point at which the lid handle is connected to the lid.

The **lid handle bar** is so attached to the lid that there is extra space for deliberate "play" or movement. This helps in centralising the lid with the rim of the cooker body which ensures better sealing.

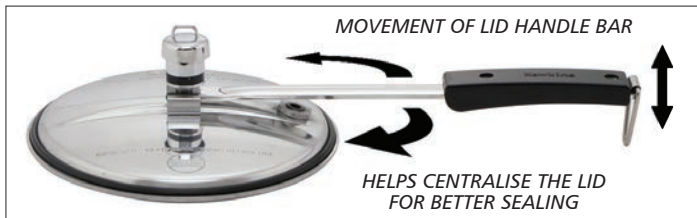

On the underside of the lid, the **vent tube nut** secures the vent tube. The vent tube nut has seven holes so that even if a few holes are clogged, the other holes will allow the escape of steam. Always keep the vent tube clean and check before every use by looking through it.

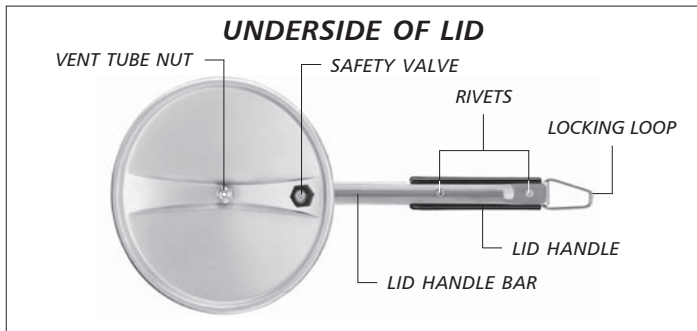

If the normal escape of steam is blocked, the **safety valve** will operate. The safety valve will also operate if there is insufficient water in the pressure cooker and it boils dry, causing the temperature to rise beyond the normal operating range. The fusible alloy in the safety valve melts at the required temperature and releases pressure. The fused safety valve must be replaced with a genuine Hawkins Safety Valve. See **Parts, Do-it-Yourself Repairs and Service**, page 84.



FUSIBLE ALLOY...



...WHICH MELTS WHEN REQUIRED

A **grid** comes with every Hawkins Pressure Cooker which is purchased with a Separator Set. Grids can be purchased separately if your pressure cooker comes without a grid. See **Using Grids, Separator Sets, Idli Stands and Molds**, page 24. ●

How to Close and Open the Hawkins

HOW TO CLOSE

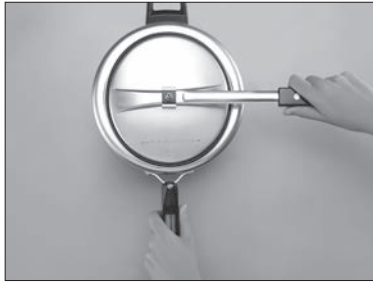

1. Hold lid just above cooker body. Lid handle must be at right angle to body handle.



2. Tilt lid into cooker and move lid away from you to wall of cooker body.



3. Move lid handle towards long body handle.



4. Lower rest of lid into cooker body by slight twist of wrist of hand holding lid handle.

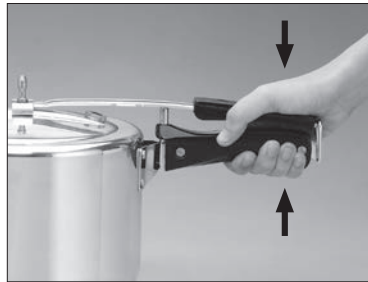

5. Place the lid handle bar on the pivot. Centralise lid. Squeeze lid handle and body handle together.

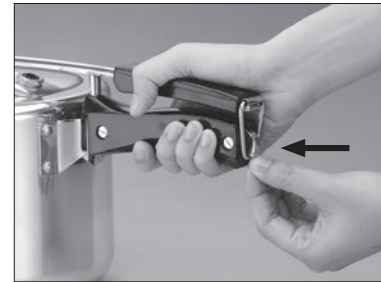

6. Push the locking loop to latch securely.

HOW TO OPEN



1. Squeeze handles together.
Release locking loop.



2. Pushing lid towards far wall of cooker body, move lid handle away from you half way to the right angle position...

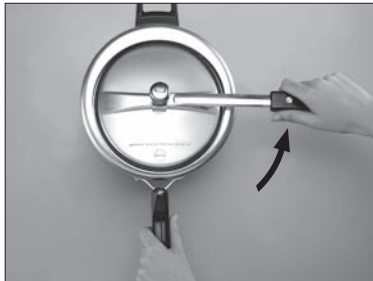

4. Move lid handle further away until at right angle to body handle.



5. Move lid out towards you.



3. ...and raise lid edge out of cooker body with a slight twist of wrist of hand holding lid handle.

Closing and opening is easy once you have understood it and practiced it a few times. Further tips for easier closing and opening are on the next page.

Tips to Make the Closing and Opening Easier

1. While closing and opening, do not tilt the lid deeply into the cooker body. The minimum tilt that will get the lid into and out of the cooker body should be used so that the lid does not touch the food inside the cooker.



2. Before latching the handles together, centralise the lid so that the gasket is in even contact with the rim of the cooker body.

3. When opening, after releasing locking loop, do not let go of the lid handle or the lid will fall into the cooker.

4. Squeeze the lid and body handles together at the end away from the cooker body. This requires the least force.

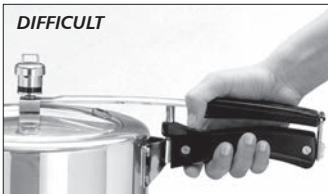

Trial Run

Even if you have used a pressure cooker previously, take a trial run before cooking in your Hawkins. This section will take you step-by-step through your trial run in about 30 minutes.

1. Preliminary Steps

Remove label and wash cooker, removing any adhesive with vegetable oil. Read pages 2–14. Identify parts. Remove and place the vent weight on the vent tube, the gasket on the lid curl. Close and open the pressure cooker a few times.



2. Placing Cooker on Stove

Pour 2 cups/480 ml water in cooker body for models from 1.5 Litre to 6.5 Litre and 3 cups/720 ml water in cooker body for models from 8 Litre to 12 Litre. Add 1 teaspoon/5 ml lemon juice or vinegar to the Classic, Contura and Ceramic-Coated Contura to prevent discolouring the cooker. For Contura Black: Do not add lemon juice or vinegar.

Remove vent weight from vent tube. **Look through vent tube and ensure it is clear.**

Check and adjust the seating of the gasket on the lid curl snugly by patting it down. Close cooker (without vent weight). Place cooker on high heat. Use the small burner of a gas stove or do not exceed the medium heat setting of a large burner for all the 1.5 Litre, 2 Litre and 3 Litre cookers (except 3 Litre Wide), the 4 Litre Contura and the 4 Litre Contura Black.

3. Ensuring a Steam-tight Seal

When water boils, hot air and/or steam should issue only from the vent tube. If steam comes out around the edge of the lid, check the centralisation of the lid thus: unlatch and reposition the lid by moving the lid slightly towards the spot where steam is escaping and relatch. **DO NOT TOUCH LID** which will be hot.

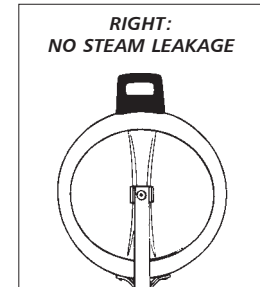
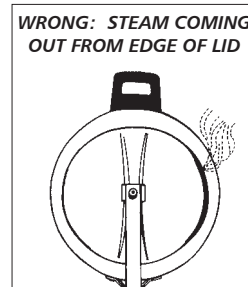

4. Placing the Vent Weight

Once steam is coming out of the vent tube steadily, place the vent weight on the vent tube and press down firmly. Keep fingers on top of the vent weight and away from the steam when placing the vent weight on the vent tube. A click indicates that the vent weight is in position. In about 1 to 3 minutes, depending upon the size of the cooker, it should come to full operating pressure – which will be indicated by the first "whistle".



5. How to Recognise Full Operating Pressure (FOP)

After the vent weight is placed on the vent tube, there is at first a very low hissing sound of steam from the vent weight. This is not FOP. Then steam emission increases to full force and the vent weight lifts with a whistling sound. The pressure cooker is now at FOP.

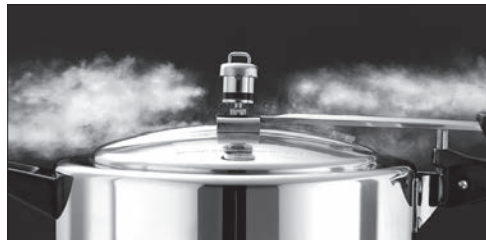

COOKER WHISTLES AT FULL OPERATING PRESSURE

When cooking, FOP is the point at which to reduce the heat and start timing the recipe.

6. Maintaining Pressure on Reduced Heat

Once full pressure is reached, reduce heat from HIGH to MEDIUM or lower. When cooking, the correct heat setting to maintain pressure on reduced heat will vary with the type and quantity of food and also your stove. The pressure inside the cooker will be maintained at 1 kgf/cm² or about 15 pounds per square inch. If the cooker whistles too frequently (more than 4 whistles per minute), reduce the heat still further.

If there is no steam coming out of the vent weight for about four minutes, increase the heat gradually until the steam comes out.

Please remember that, particularly on electric hot plates, it may take some time for heat level adjustments to have an effect on the frequency of whistles. A little practice will make clear the correct heat setting and adjustments, if any, that may be required.

7. Releasing Pressure

Turn off heat. Remove pressure cooker from heat. With a fork, slightly lift vent weight to release steam. Do not remove vent weight. When cooking, release pressure as indicated in the recipe or in **Cooking Tips**, pages 21 and 22, **Releasing Pressure**.

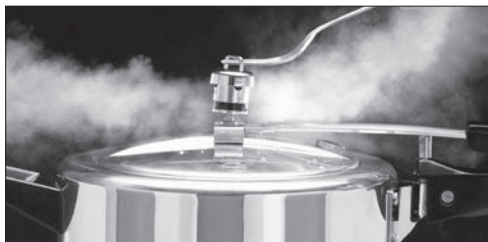

RELEASE PRESSURE WITH SLIGHT LIFTING OF VENT WEIGHT WITH A FORK

8. Final Steps

With a fork, again slightly lift vent weight to ensure that there is no unsafe pressure in the cooker. Open cooker. Empty out water. Remove vent weight. Wash and wipe dry body, lid and vent weight. Store without closing the pressure cooker. Before cooking in your Hawkins, READ THE REMAINING INSTRUCTIONS. ●

Cooking Tips

Read this section after doing the Trial Run and before cooking in your Hawkins.

Heat Source

- The Hawkins is specially suitable for use on domestic gas and kerosene stoves. After some use, the cooker base may not retain the flatness required for use on an electric hot plate. These Hawkins cookers are not Induction Compatible.
- Use a burner to suit the size of the cooker – gas flames should not lick the sides of the cooker. When cooking in 1.5 Litre, 2 Litre and 3 Litre cookers (except 3 Litre Wide), 4 Litre Contura and 4 Litre Contura Black, use the small burner or do not exceed the medium heat setting of a large burner.
- The cooker can be used on wood or coal fires provided it is not in direct contact with hot coals. **WARNING: DIRECT CONTACT WITH HOT COALS CAN DAMAGE THE METAL.** There should be at least a 1 inch/2.5 cm gap between the burning coals and the base of the cooker. On wood or coal fires, reduce heat when required by reducing the fuel or increasing the distance of flame to the cooker. On improvised fires or commercial burners,



limit the heat to the level usually found in domestic stoves. These Hawkins cookers must not be used on an industrial burner.

- When cooking foods that sprout excessively such as certain pulses or legumes, bring cooker to full operating pressure on **medium** heat and reduce heat as soon as FOP (Full Operating Pressure) is reached.

Ingredients

- Do not cook or store food items which are acidic in nature such as tomatoes for more than 1 hour in the pressure cooker.
- See **Measurements**, page 40 for information on weights and measures.
- The pressure cooker should not be filled more than its appropriate capacity. See **Getting to Know Your Hawkins**, page 9 and the chart on **Maximum Cooking Capacities and Volumes for Different Sizes of Hawkins**, page 41.

QUANTITY

- The recipes in this Manual state the maximum quantities to be cooked in the 5 Litre Hawkins cooker. When cooking reduced quantities, always ensure there is enough cooking liquid for the entire pressure cooking time as explained in various parts of this section.

- To adjust these recipes to other sizes of these Hawkins cookers, see **Maximum Cooking Capacities/Volumes for Different Sizes of Hawkins**, page 41 and **Adjusting the Recipes for Pressure Cooker Sizes Other than 5 Litre**, page 55.
- Never reduce cooking liquid in recipes/charts where the total liquid is $\frac{3}{4}$ cup (or less).

SIZE OF FOOD

- In general, the size of the individual pieces of food and not the total quantity determines the cooking time.
- Smaller individual pieces of food will cook faster than larger pieces of the same food.
- Cut food in even sizes for even cooking.

COMBINING FOODS

- Ingredients requiring roughly the same cooking time can be cooked together without mixing their flavours if kept physically separated and not mixed in the same liquid.
- Ingredients with different cooking times may be cooked together by using the following techniques:
 1. Speed up cooking time by cutting food into smaller pieces and by presoaking lentils, beans and cereals.
 2. Slow down cooking time by cutting food into larger pieces and by wrapping in foil.

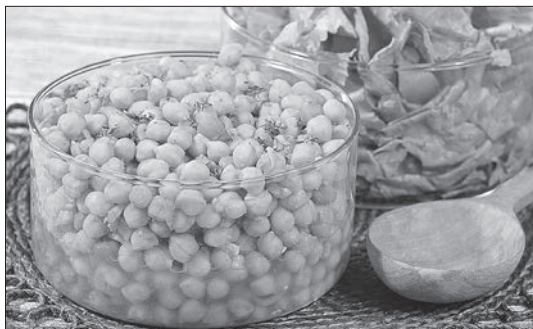

3. Start longer-cooking ingredients first, interrupt pressure cooking to add quicker-cooking ingredients and then complete pressure cooking.

SUBSTITUTIONS

The salt and other seasonings in the recipes may be varied or eliminated according to your taste or health requirements.

Frying Prior to Pressure Cooking

- Some recipes require light, shallow frying before pressure cooking. Shallow frying or browning in a small amount of butter, oil or other fat can be done in the pressure cooker body without the lid. **Take care not to bang the ladle against the rim of the cooker body.** Do not leave a ladle in the cooker body while frying.
- Browning meat and poultry before pressure cooking helps to seal in the juices and improves the appearance and taste of the food. If you want to eliminate the additional fat and/or save time, browning can be omitted.
- Brown pieces of food in small batches to keep the oil temperature high so the food is seared but does not cook. Brown all sides evenly.
- After frying, remove cooker body from heat before adding liquid to the cooker.

- It is a safety requirement that deep-frying, involving more than ½ cup oil or frying more than 20 minutes at a time, is not done in the pressure cooker body.
- Do not pressure-fry in the pressure cooker. This is also a safety requirement.

Water

- There must be enough water or cooking liquid that contains water, such as stock, juice, vinegar, beer or wine, in the pressure cooker to produce steam throughout the entire pressure cooking time and to prevent burning and to prevent the cooker from boiling dry. Oils and fats do not produce steam and should not be counted as cooking liquid for steam.
- The general recommendation when not following a recipe, chart or cooking your own proven recipe is,
 1. For 1.5 to 3 Litre cookers: place a minimum of 1 cup/ 240 ml water for the first 10 minutes of pressure cooking time plus ½ cup/120 ml for every subsequent 10 minutes or part thereof.
 2. For 3.5 to 6 Litre cookers: place a minimum of 1½ cups/ 360 ml water for the first 10 minutes of pressure cooking time plus ½ cup/120 ml for every subsequent 10 minutes or part thereof.
 3. For 6.5 to 12 Litre cookers: place a minimum of 2 cups/ 480 ml water for the first 10 minutes of pressure cooking time



plus ½ cup/120 ml for every subsequent 10 minutes or part thereof. This quantity will prevent boiling dry provided you reduce the heat when cooker has reached FOP (Full Operating Pressure).

- Some of the recipes have less (or more) cooking liquid than the amount prescribed in the preceding paragraph. This is because foods such as meat, fish, poultry, tomatoes and other vegetables give off juices during cooking (whereas pulses or legumes and rice absorb liquid). The recipes and charts reflect this.
- Do not cook with less cooking liquid than stated in the recipe or chart as you run the risk of either a ruined recipe or having to replace a safety valve – or both.
- If you open the cooker and decide to pressure cook longer, always check that there is enough cooking liquid to cook the additional time.

- **The Hawkins Pressure Cooker should never be used as an oven for dry heating or baking as it may reduce the strength of the metal.**

Vent Weight

Allow steam to start issuing from the vent tube in a steady stream before placing the vent weight (see **Trial Run**, page 16, point **4. Placing The Vent Weight**).

Adjusting Heat

- When the Hawkins has reached FOP (see *Trial Run*, page 16, point 5. **How to Recognise Full Operating Pressure (FOP)**), reduce the heat to medium or lower. If the cooker whistles too frequently (more than 4 whistles per minute), reduce the heat still further. If there is no steam coming out of the vent weight for about four minutes, increase the heat gradually until the steam comes out. The heat setting required varies according to the type and quantity of food in the cooker and the stove.
- Cooking on high heat after full pressure is reached does not result in faster cooking. It wastes energy and increases the likelihood of boiling dry and/or spoiling the food.
- When cooking on wood stoves or camp fires, move the pressure cooker to a cooler part of the stove or shift cooker partly off the burner to cook at reduced heat ensuring that cooker is not tilted.

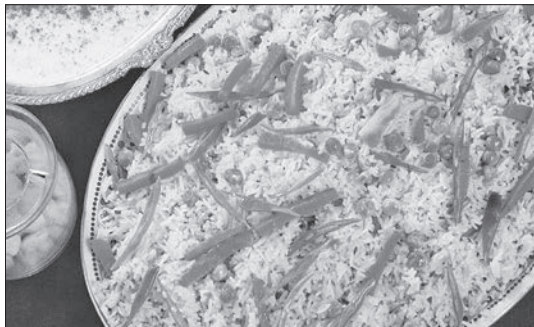

Timing

- Reaching full operating pressure (first whistle) is also the signal to start timing the recipe/food.
- Use a kitchen timer or watch/clock. Exact timing is critical to successful pressure cooking. Counting whistles may give you the wrong time required for cooking because the whistle frequency

varies with the heat level, cooker size and food. If in doubt, cook for less time rather than more. It is possible to correct undercooking by cooking or pressure cooking more.

- If the food is only slightly undercooked, you may be able to complete the cooking without pressure. This method is especially suitable for foods which are easily overcooked. If the food requires more pressure cooking, decide how many minutes, ensure there is enough cooking liquid for the extra time, and bring cooker back to FOP (Full Operating Pressure) and cook the additional time.
- Cooking times given in this Manual are a guide. More or less time may be necessary depending on the age, tenderness and variety of the ingredients and how well cooked you prefer the food to be. Experience will enable you to adjust the times suitably.
- "Pressure Cooking Time 0 minute" in the charts and recipes signifies that the pressure cooker is to be taken off the heat as soon as the pressure cooker has reached FOP (Full Operating Pressure).

Releasing Pressure

- There are three methods to release pressure in these Hawkins cookers.
 1. **"Allow to cool naturally."** Remove the cooker from heat and leave it until the pressure has dropped to normal and then the

lid can be opened. This takes from 10 to 20 minutes, depending on the type and quantity of food and the size of the cooker. This method is required for soups, legumes, custards and cakes.

2. "Release pressure immediately." Remove the cooker from heat and lift the vent weight slightly with a fork, allowing all the steam to escape, then open the lid immediately. This method is required for easily overcooked foods such as delicate vegetables and fish. This method cannot be used when the cooker contains predominantly liquid or frothing foods as the food/liquid may spurt out.

3. "Release pressure by placing cooker in up to 4 inches/10 cm of cold water in a basin or in a sink for a few minutes." The height of the water depends on the size of the cooker. Place a small cooker in about 1½ inches/4 cm of cold water. Open when the pressure has fallen. Do not run water over the lid. This method is required when the cooker contains liquid or frothing foods which need to be opened immediately.

- Each recipe indicates the method of releasing pressure. Some foods, such as Basmati rice, are cooled naturally for 5 minutes before releasing steam.
- The method of releasing pressure has a bearing on the pressure cooking time. If you change from immediate opening to cooling naturally, reduce pressure cooking time by 2 to 3 minutes.

Similarly, if you change from cooling naturally to immediate opening, increase pressure cooking time by 2 to 3 minutes.

Adapting Your Recipes to Pressure Cooking

- Most foods that can be cooked with moist heat – boiled, steamed, braised and stewed – are suitable for pressure cooking.
- The recipes and charts in this Manual are examples of the correct way to cook in these Hawkins cookers. Find a recipe in the Manual similar to yours and use broadly similar methods, food and water quantities and cooking times.



- If there is no similar recipe to match for timing, a general rule is to pressure cook one-third the normal cooking time and then check the food for doneness. If undercooked, reclose the pressure cooker and cook for a suitable amount

of additional time.

- There is less evaporation in pressure cooking compared to open pot cooking so liquid quantity ordinarily has to be reduced – always ensuring there is enough liquid for the entire cooking time (see **Water**, page 20).
- Pressure cooking retains flavours so season with restraint. Taste and add more seasoning, if required, after pressure cooking.
- Milk, cream and yogurt tend to curdle and froth when pressure cooked and should generally be added to recipes after pressure cooking.

How to Get the Best Out of Recipes in this Manual

- Read the entire recipe before beginning to work. Assemble and prepare ingredients as required.
- Unless otherwise noted, in the recipes:
 1. All foods are to be appropriately cleaned and washed.
 2. Ash gourd, carrots, drumsticks, fresh ginger, garlic, onions, potatoes, raw bananas, red pumpkin and yam are to be peeled.
 3. Remove excess fat from meat.
- If you come across a term you do not know, check **Glossary (Meanings and Methods)**, page 79. For translations of ingredients in other languages, see hawkins.in/translations.

Saving Energy

To obtain optimum energy efficiency while cooking with these Hawkins cookers:

1. Place the vent weight on the vent tube as soon as the steam is coming out of the vent tube steadily (see **Trial Run**, page 16, point **4. Placing the Vent Weight**).

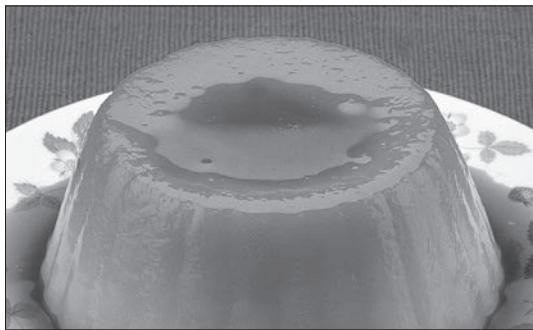

2. Reduce heat as soon as the Hawkins has reached FOP (Full Operating Pressure). Reduce heat to a heat setting such that the pressure inside the cooker will be maintained (see **Trial Run**, page 16, point **6. Maintaining Pressure on Reduced Heat**).

How to Prevent Unnecessary Fusing of the Safety Valve

1. **Check** that the vent tube is clear by looking through it.
 2. **Do not** fill the cooker more than two-thirds (for liquid foods, not more than half; for foods that froth/sprout, not more than one-third).
 3. **Do not** place the pressure cooker on an industrial burner or stove – use only a domestic stove.
 4. **Do** put enough water for the cooking time. (Check water quantities in this Manual).
 5. **Do** reduce heat to medium or lower when the pressure cooker reaches FOP (see

Trial Run, page 16, point **6. Maintaining Pressure on Reduced Heat**).

6. **Do** take the pressure cooker off the stove when the cooking time is complete (check cooking time in chart or recipe as appropriate). ●

Using Grids, Separator Sets, Idli Stands and Molds

Accessories make your Hawkins Pressure Cooker even more useful.

Hawkins Separator Sets and Grids

The Hawkins Classic Pressure Cooker can be purchased with an aluminium Separator Set and grid or without the Separator Set and grid in 5 Litre, 6.5 Litre and 10 Litre sizes. The grid is used for minimising the contact between food and the cooking liquid and/or the base. The Separator Set (containers along with a stand) can be used for cooking two or three dishes at a time.



The Separator Sets are designed to be used WITHOUT a grid.

Using Grids

The grid should not be used when cooking soups, stews, rice dishes, *dal*, pulses or legumes and similar foods or when cooking with a Separator Set. The height of the grid is about 1/2 inch/1.3 cm. This height should be taken into consideration when calculating how much remaining space is available for food.

- To steam food above the water (rather than immersed in liquid with flavours blending). For example, potatoes cooked on a grid instead of directly on the base may have a better texture and taste.
- To place molds or other containers (not provided) on it, when steaming foods in them to provide stability for the mold.



- As a coaster or pad for the hot cooker body (not on fine furniture).



Using Separator Sets

- In the base of the 5 Litre cooker, use a minimum 1½ cups/ 360 ml water; in the base of the 6.5 Litre and 10 Litre cooker, use a minimum 2 cups/480 ml water for the first 10 minutes of pressure cooking time plus ½ cup/120 ml for every subsequent 10 minutes or part thereof.
- To prevent discolouring aluminium when using separator sets or containers in the Classic, Contura and Ceramic-Coated Contura, add 1 teaspoon/5 ml lemon juice or vinegar for every 2 cups/ 480 ml water in the base of the cooker. For Contura Black: Do not add lemon juice or vinegar.
- Each container can be used individually with or without the stand. Containers can be used for steaming foods which are to be kept out of water. Place container on grid if using without the stand. When using containers with the stand, do not use the grid.
- **Reheating/Thawing.** Containers or molds can be used to reheat food, including precooked frozen food, in the cooker. To reheat food: put food in the container. Cover with aluminium foil those foods which you want to keep dry. Cooked rice should be reheated uncovered. A container full of cooked rice will require 2 minutes pressure cooking time. A frozen dinner requires about 10 minutes at pressure. With experience you will be able to judge the time. Add water according to the cooking time. Put grid in cooker. Place container on grid. Close cooker. Bring to full pressure on high heat. Reduce heat and cook the required time. Remove cooker from heat. Release pressure immediately.
- The chart below gives useful information for the three types of Separator Sets:

Separator Set for	No. of Containers	Individual Container	Net Volume	May be Used in...	
				Classic	Contura and Contura Black
5 Litre	2 containers	Top	3½ cups / 840 ml	5 Litre, 6.5 Litre, 8 Litre Tall, 8 Litre (Wide), 10 Litre, 12 Litre	6.5 Litre
		Bottom	5 cups / 1.2 litres		
6.5 Litre	3 containers	Top	3½ cups / 840 ml	6.5 Litre, 8 Litre Tall, 10 Litre, 12 Litre	Nil
		Middle	3¼ cups / 780 ml		
		Bottom	5 cups / 1.2 litres		
10 Litre	3 containers	Top	4¾ cups / 1.1 litres	10 Litre, 12 Litre	Nil
		Middle	3½ cups / 840 ml		
		Bottom	8½ cups / 2 litres		

How to Cook with Separator Sets

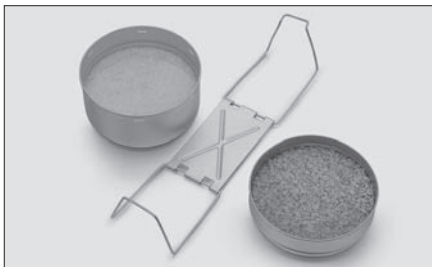

1. Load the containers with ingredients outside the pressure cooker body. Also, put water if and as required.

For maximum quantities of various foods that can be put in different Separator Sets, see chart on facing page, page 27.



4. Place the Separator Set in the pressure cooker.



2. Stack the containers on the stand. Close wire handles around stacked containers and inter-lock them.



5. Close the pressure cooker and cook for the required time following the same procedure as for non-separator cooking.



3. Pour the required quantity of water into cooker body.



6. Release pressure as appropriate. Open cooker. Remove the Separator Set using tongs (not provided) as it will be hot. Wash cooker and wipe dry.

Maximum Quantities of Various Foods for the Hawkins Separator Sets

Separator Set	Container	Item	Quantity in Cups		Quantity in g/ml	
			Food	Water	Food	Water
5 Litre	Top	Tuvar dal *	¾	1½	150 g	360 ml
		Moong dal *	½	1	100 g	240 ml
		Potatoes (whole)	5 medium	–	500 g	–
	Bottom	Colam Rice	1½	2	300 g	480 ml
		Basmati Rice	1½	2	300 g	480 ml
		Parboiled Rice	1¼	2⅛	250 g	510 ml
6.5 Litre	Top	Potatoes (whole)	5 medium	–	500 g	–
	Middle	Tuvar dal *	½ + ⅛	1¼	125 g	300 ml
		Moong dal *	½	1	100 g	240 ml
	Bottom	Colam Rice	1½	2	300 g	480 ml
		Basmati Rice	1½	2	300 g	480 ml
		Parboiled Rice	1¼	2⅛	250 g	510 ml
10 Litre	Top	Potatoes (whole)	8 medium	–	800 g	–
	Middle	Tuvar dal *	¾	1½	150 g	360 ml
		Moong dal *	½	1	100 g	240 ml
	Bottom	Colam Rice	2½	3⅓	500 g	800 ml
		Basmati Rice	2½	3⅓	500 g	800 ml
		Parboiled Rice	2	3⅓	400 g	800 ml

For each Separator Set:

● **Water in Cooker Body:**

For 5 Litre: 1½ cups/360 ml.

For 6.5 Litre and 10 Litre: 2 cups/480 ml.

● **Pressure Cooking Time:** 10 minutes.

● **Pressure Release:** Allow to cool naturally.

You may also cook mutton curry ** using containers as follows:

1. In 5 Litre and 6.5 Litre Separator Sets, 340 g mutton curry in the top container. This includes 250 g mutton and about ½ cup/90 g gravy, which should be made separately in another pan and added to the container with mutton for pressure cooking. Water in cooker body: 2 cups/480 ml in the 5 Litre, and 2½ cups/600 ml in the 6.5 Litre. Pressure Cooking Time: 20 minutes. Pressure Release: Allow to cool naturally.

2. In 10 Litre Separator Set, 475 g mutton curry in the top container. This includes 350 g mutton and about ⅔ cup/125 g gravy, which should be made separately in another pan and added to the container with mutton for pressure cooking. Water in cooker body: 2½ cups/600 ml. Pressure Cooking Time: 20 minutes. Pressure Release: Allow to cool naturally.

** Do not cook moong dal with mutton curry as the dal will overcook.

* Add 1 tsp/5 ml salt plus ¼ tsp/1.3 ml turmeric per cup of dal, to dal and water in container while loading the containers.

Hawkins Two-Dish and Three-Dish Sets



The hard anodised Hawkins Two-Dish Set and Three-Dish Set are available as accessories. The Two-Dish Set is suitable for use in many of our pressure cooker models between 4 Litre and 6 Litre, and the Three-Dish Set is suitable for use in many of our pressure cooker models between 6.5 Litre and 12 Litre.

The use and care instructions and recipes are given in the Manual accompanying the Sets.

Hawkins Idli Stands

You can cook delicious idlis in your Hawkins Pressure Cooker using the Hawkins Idli Stand. Instructions for use and care and recipes for idlis, momos, *sambar* and chutney are included with each Hawkins Idli Stand.



The Hawkins aluminium Idli Stands have been designed for the Classic 3 Litre (Tall), 5 Litre and 6.5 Litre and the Hawkins stainless steel Idli Stand is designed for the Classic 5 Litre – but can be used with various Hawkins cookers as shown below.

Idli Stand for	Product Code	Designed for Classic	Can also be Used in...	
			Classic	Contura, Contura Black & Ceramic-Coated Contura
Aluminium Idli Stands				
12 Small Idlis	ID 12S	3 Litre (Tall)	5 Litre, 6.5 Litre, 8 Litre (Tall), 8 Litre (Wide), 10 Litre, 12 Litre	4 Litre, 5 Litre, 6.5 Litre
12 Medium Idlis	ID 12L	5 Litre	6.5 Litre, 8 Litre (Tall), 8 Litre (Wide), 10 Litre, 12 Litre	6.5 Litre
18 Medium Idlis	ID 18L	6.5 Litre	8 Litre (Tall), 10 Litre, 12 Litre	Nil
Stainless Steel Idli Stand				
12 Medium Idlis	SSID 5	5 Litre	6.5 Litre, 8 Litre (Tall), 8 Litre (Wide), 10 Litre, 12 Litre	6.5 Litre

Using Molds

Molds are not supplied with Hawkins Pressure Cookers. You may use your own molds as explained herein below:

- Molds made of oven-proof metal, glass or ceramic can be used if they fit inside the cooker. The thicker the mold, the longer the cooking time.
- Recipes such as custards, steamed puddings and fruit crumbles require cooking in a mold which is put inside the cooker. Foods such as rice, lentils and fish may also be cooked in molds to reduce the clean-up required for the cooker or the handling of delicate food or to heat food without wetting it.
- Molds should be placed on the grid. A mold should fit inside the cooker such that the top of the mold is not above two-thirds of the height of the cooker body.
- When required, cover the mold with foil or a double thickness of greaseproof paper and tie securely. A handle made from string is useful for transferring molds in and out of the cooker.
- There are three different ways in which a mold can be used with a Hawkins Pressure Cooker:



for pressure cooking an item; for steaming an item without pressure; and for steaming an item without pressure and then pressure cooking it. The recommended water quantities for each of these three different ways is given below:

1. For Pressure Cooking:

- a. **For 1.5 Litre to 3 Litre cookers:** put a minimum of 1 cup/ 240 ml water in the base of the cooker for the first 10 minutes of pressure cooking time plus $\frac{1}{2}$ cup/120 ml for every subsequent 10 minutes or part thereof. *
- b. **For 3.5 Litre to 6 Litre cookers:** put a minimum of $1\frac{1}{2}$ cups/ 360 ml water in the base of the cooker for the first 10 minutes of pressure cooking time plus $\frac{1}{2}$ cup/120 ml for every subsequent 10 minutes or part thereof.
- c. **For 6.5 Litre to 12 Litre cookers:** put a minimum of 2 cups/ 480 ml water in the base of the cooker for the first 10 minutes of pressure cooking time plus $\frac{1}{2}$ cup/120 ml for every subsequent 10 minutes or part thereof.

- * The amount of water that can be put in the base of all pressure cookers when using molds – especially in the small cookers (1.5 to 3 Litre) is limited by the stability of the mold(s) on the grid and the potential of water boiling into the mold(s). These considerations are to some extent dependent on the size, weight and height/shape of the mold(s). The limitation on water necessarily limits the pressure cooking time. For example: If 2 cups/240 ml water is the maximum water quantity that allows a mold to be

stable on the grid in a small pressure cooker, the maximum pressure cooking time is 30 minutes (1 cup/240 ml water for the first 10 minutes pressure cooking time + ½ cup/120 ml water for the next 10 minutes + ½ cup/120 ml water for the next 10 minutes).

2. **For Steaming without Pressure:** Do not place the vent weight and put water as recommended on page 29 in the base of the cooker. Put the cooker on high heat until steam comes out of the vent tube steadily and then reduce heat to medium; if required, adjust the heat to maintain a steady escape of steam throughout the time for steaming.
3. **For Steaming without Pressure and then Pressure Cooking:** For initial steaming without pressure and then cooking under pressure, add water as recommended on page 29 in the base

of the cooker. Heat the cooker (without vent weight) on high heat until steam passes through the vent tube. Reduce heat to maintain a steady escape of steam from the vent tube and cook for the required steaming time. Then place the vent weight on the vent tube and increase the heat to high until the cooker comes to FOP (Full Operating Pressure). Reduce heat to maintain pressure and cook in the usual way for the required time.

- To prevent discolouring aluminium when steaming in molds in the Classic, Contura and Ceramic-Coated Contura, add 1 teaspoon/5 ml lemon juice or vinegar for every 2 cups/480 ml of water in the base of the cooker. Do not add lemon juice or vinegar when using a mold in the Contura Black.
- To reheat food in molds, see **Reheating/Thawing**, page 25. ●

Care and Cleaning

Body and Lid

- Remove label, wash, rinse and dry cooker before use (do not wash in a dishwasher).
- Remove any adhesive by rubbing a little vegetable oil with a piece of cloth.
- Do not hit or knock the rim of the cooker body with a ladle, spoon or any other object. Protect the edge of the lid from all knocks and dents which may disturb the sealing of the cooker.
- Do not bang cooker down on pan supports. Lift cooker from the pan supports – do not drag it across the pan supports.
- Do not cook or store food items which are acidic in nature such as tomatoes for more than 1 hour in the pressure cooker. Do not leave other food or water for more than 4 hours in the pressure cooker. Do not leave the cooker lying in water or with dirty dishes for long. Chemicals and natural salts in the water and decomposing food can cause pitting of the metal.
- Do not leave salted liquid, vinegar, lemon juice, mayonnaise or mustard in the cooker. Never add salt to the cooker when there is no liquid in the cooker. First add the liquid, warm it, then add the salt and stir until the salt is completely dissolved.
- Do not put the hot cooker in cold water – allow to cool first.

For the Ceramic-Coated Contura:

1. Protect the exterior ceramic coating from chipping and

scratching by not hitting, cutting or banging it or the rim of the cooker body with any hard or sharp objects.

2. After use, faint scratches or marks may appear on the exterior ceramic coating. These are marks of normal wear and tear and do not affect the performance of the cooker. The coating is non-toxic and inert.

Handles

- Plastic handles may break under a blow.
- Do not attempt to remove the "play" or movement provided for the lid handle bar where it is attached to the lid. The "play" is designed deliberately and is essential for proper sealing.

Rubber Gasket

- Do not stretch the gasket, particularly when it is hot, as it may distort over time.
- Replace the gasket when it becomes hard or cracked and no longer seals.
- Before replacing at the first sign of not sealing, check that the gasket is sitting flush in the lid curl and that the lid is properly centered. Sometimes, just moving the gasket around or inverting it stops the leak. Do not invert the gasket of 8 Litre (Wide), 10 Litre and 12 Litre cookers – see **Getting to Know Your Hawkins**, page 9.

General Cleaning Tips

- DO NOT WASH PRESSURE COOKER OR ANY OF ITS PARTS IN A DISHWASHER. Dishwasher detergents are likely to contain harsh chemicals or abrasive substances which may tarnish the aluminium, damage the hard anodised finishes and may dull the plastic handles and the stainless steel mirror finish. We recommend hand washing the cooker.
- Wash and dry every surface of the cooker soon after use. If not removed, food can corrode the metal over a period of time or lead to "baked-on stains".
- Wash all parts of the cooker in hot water with a mild liquid soap or detergent such as 'Pril' or 'Vim' liquid and a dishcloth or non-abrasive sponge. Rinse and wipe dry thoroughly. Aluminium can become pitted if left wet.
- Remove food stuck to the cooker with a non-abrasive plastic scrubber and a non-abrasive cleanser such as 'Vim' bar or 'Odopic' powder. Soaking in hot water may make cleaning easier. For Contura Black and any hard anodised surfaces on Hawkins cookers and accessories, ensure any cleansers are suitable for hard anodised aluminium or use mild soap.
- Do not use harsh abrasives such as steel wool, steel brushes, ash or mud to clean the cooker. This can cause scratches and could lead to pitting.
- If food is badly stuck or burned, the following procedure may help dislodge food particles and make cleaning easier: pour into cooker enough water (not above half full) to cover the area of burned

food. Close cooker. Bring to full pressure on high heat. Reduce heat and cook 5 minutes. Allow to cool naturally. Open cooker. Wash and wipe dry. Do not use abrasive powders, ash, mud, bleach or soda. For stubborn spots, a fine soap-impregnated steel wool pad may be used **gently**.

- Carefully remove the gasket when washing the lid. Gently wipe or wash and rinse the gasket without stretching it. If food is lodged in the lid curl, remove the gasket and clean the lid curl with a sponge or a brush. Dry lid and gasket thoroughly before reassembling.
- Check that the vent tube is clear after rinsing. If it is clogged, clean by carefully pushing a wire through the vent tube. Rinse with running water.
- The vent weight can be cleaned with a jet of water to clear the holes inside. The colour of the black spring of the vent weight may wear off over time. This is normal wear and does not affect its functioning.
- With use, the aluminium cooker body and lid of the Classic and Contura may lose their shine. The loss of shine is the normal behaviour of the metal over time.
- Clean the area between the lid and the lid handle bar with a brush as required.



- To avoid spoiling the outside surface of all Contura cookers keep the cooker body in an upright position while cleaning (Figure A). If it is necessary to place the cooker body on its side for cleaning, keep a folded kitchen cloth or a piece of any other soft material such as rubber or sponge underneath (Figure B).

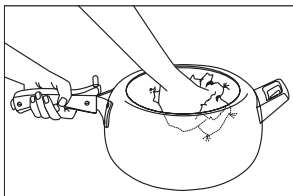

FIGURE A

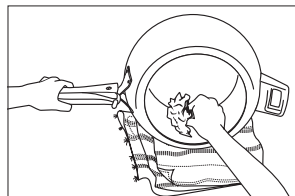

FIGURE B

- For Contura Black: Metallic marks – often from gas stove pan supports – may appear on the base. To remove metallic marks from base: apply a kitchen cleanser suitable for hard anodised aluminium to the marks and rub with an abrasive kitchen scrubber such as Scotch-Brite or fine steel wool.
- Cleaning instructions for pressure cookers are applicable to the Hawkins Grids, Separator Sets and Idli Stands.

Baked-on Stains

- If the pressure cooker is not cleaned thoroughly after each use, a thin layer of food or grease may remain. When the cooker is heated next, this food/grease becomes "baked-on" and very difficult to remove. Avoid "baked-on" fat or gravy stains; wipe off any fat or gravy on the cooker base before placing on hot stove. Ensure stove surface in contact with pressure cooker is free of fat drippings.
- If you do get "baked-on" stains on the exterior or base, tackle them while they are still fresh. Soak in hot water for 30 minutes before washing to remove burnt food more easily.
 1. **For Classic, Contura and Contura Black:** Make a thick paste of a chlorine-based kitchen cleanser and apply it to the surface. Wait 5 to 10 minutes, then scour lightly with fine steel wool using a circular motion. Wash and wipe dry.
 2. **For Ceramic-Coated Contura:** Wash with a mild liquid utensil soap or detergent and a non-abrasive plastic scrubber, removing all superficial food, and dry. Make a paste with equal parts of baking soda and warm water and apply it to the area of the ceramic coating with the stain. Wait 5–10 minutes. Rub paste with a non-abrasive plastic scrubber using a circular motion until stains are removed. Wash cooker in hot soapy water and wipe dry.

Removing Stains Caused by Chemicals in the Water

Note: Do not use this method for Contura Black as it may damage the hard anodised finish.

- The inside of the Classic, Contura and Ceramic-Coated Contura cooker body may become darker due to minerals in the water. This darkening is neither injurious to health nor does it affect the taste and quality of food.
- To remove stains from inside the cooker body: fill cooker with water to half its capacity. Add 2 teaspoons/10 ml lemon juice or tartaric acid (cream of tartar) for each litre of water. Bring cooker to full pressure on high heat and cook 15 minutes.
- If you wish to remove stains from the upper half of the cooker body, do not pressure cook. Fill cooker with enough of the same water-tartaric acid solution to cover the stains. Boil 30 minutes.
- Wash and then dry with a soft, clean cloth.

Storing

- Allow the cooker and all its parts to dry completely before storing.
- The gasket should be stored fitted in the lid curl.
- Store the cooker open to avoid mustiness.
- **For Ceramic-Coated Contura:** When storing, ensure that the ceramic coating is not hit, gouged or rubbed against any hard or sharp surfaces. Do not stack other utensils on the cooker without protecting it. ●

What to Do if This Happens...

The possible causes of and solutions to various problems that may occur are given in the following chart.

If This Happens...	Causes	Solutions
A. Food Undercooked	1. Pressure did not build correctly	a. Ensure vent weight is placed correctly (see Getting to Know Your Hawkins , page 10, first column and Trial Run , page 16, point 4. Placing the Vent Weight).
		b. Look at safety valve on the underside of lid. If part of the safety valve is open, it has fused and must be replaced with a genuine Hawkins safety valve (see Parts, Do-It-Yourself Repairs and Service , pages 84-89).
	2. Inaccurate timing of recipe	a. Time accurately (see Cooking Tips , page 21, Timing).
		b. Check that the pressure cooking time used is correct. Food varies in tenderness for various reasons as does personal taste. Ensure there is enough water, close cooker and cook longer or simmer food without the lid until cooked as desired.
	3. Pressure release method not accounted for in the pressure cooking time	Pressure cooker has been opened immediately when the pressure cooking time is based on allowing to cool naturally (see Cooking Tips , page 21–22, Releasing Pressure).

Chart continued overleaf

If This Happens...	Causes	Solutions
B. <i>Dal</i> Sprouting	1. Too much food in cooker	Do not fill the cooker body (<i>dal</i> and water combined) to more than one-third. Do not exceed <i>dal</i> and water quantities (see Cooking Dal , pages 46–47, Dal Pressure Cooking Chart). Follow recommendations for reducing sprouting (see Cooking Dal , page 45, To Reduce Dal Sprouting)
	2. Excessive heat from burner	a. Use a burner to suit the size of the cooker – gas flames should not lick the sides of the cooker and the hot plate of an electric stove should be of a diameter not more than that of the base of the pressure cooker.
		b. Reduce heat to medium or lower as soon as pressure cooker reaches FOP (see Trial Run , page 16, point 5. How to Recognise Full Operating Pressure (FOP) and point 6. Maintaining Pressure on Reduced Heat).
	3. Pressure cooking <i>moong</i> and <i>urad dal</i> in 1.5 Litre, 2 Litre and 3 Litre cookers	Do not cook these <i>dal</i> in the 1.5 Litre, 2 Litre and 3 Litre cookers.
	4. Pressure released by lifting the vent weight	Do not release pressure by lifting the vent weight. Allow to cool naturally.
C. Inside of Cooker Body Darkening	Substances dissolved in water	Remove stains (see Care and Cleaning , page 34, Removing Stains Caused by Chemicals in the Water).

If This Happens...	Causes	Solutions
D. Safety Valve Fused (melted or has an opening)		Replace safety valve with a genuine Hawkins safety valve (see Parts, Do-It-Yourself Repairs and Service , pages 84–89).
	1. Excessive heat from heat source	<p>a. Do not use cooker on an industrial burner/stove – use only on a domestic burner/stove.</p> <p>b. Use a burner to suit the size of the cooker – gas flames should not lick the sides of the cooker and the hot plate of an electric stove should be of a diameter not more than that of the base of the pressure cooker.</p> <p>c. When cooking in the 1.5 Litre, 2 Litre and 3 Litre cookers (except 3 Litre Wide), the 4 Litre Contura and the 4 Litre Contura Black, use the small burner or do not exceed the medium heat setting of a large burner.</p>
	2. Cooker boiled dry	<p>a. Always ensure there is enough water/cooking liquid for the entire cooking time (see Cooking Tips, page 20, Water).</p> <p>b. Reduce heat to medium or lower as soon as pressure cooker reaches FOP (see Trial Run, page 16, point 5. How to Recognise Full Operating Pressure (FOP) and point 6. Maintaining Pressure on Reduced Heat).</p> <p>c. Time accurately and remove cooker from heat when the pressure cooking time is completed (see Cooking Tips, page 21, Timing).</p>
	3. Vent tube/vent weight blocked	<p>a. Always check that the vent tube is clear by looking through it before closing cooker (see Trial Run, page 15, point 2. Placing Cooker on Stove).</p> <p>b. Clean vent tube and vent weight after cooking.</p> <p>c. Do not fill cooker more than the stated capacity (see Getting to Know Your Hawkins, page 9, Food Preparation and Maximum Cooking Capacities/Volumes for Different Sizes of Hawkins, page 41). Avoid sprouting to prevent clogging the vent tube (see point B. Dal Sprouting, page 36).</p>

Chart continued overleaf

If This Happens...	Causes	Solutions
E. Steam Leaking Around Lid	1. Pressure cooker not closed properly	Close cooker properly (see How to Close and Open Your Hawkins , page 12, How to Close) and adjust for a steam-tight seal (see Trial Run , page 15, point 3. Ensuring a Steam-tight Seal).
	2. Gasket is:	
	a. Not fitted properly	a. Seat gasket properly in lid curl (see Getting to Know Your Hawkins , page 9).
	b. Dirty	b. Clean gasket and lid curl (see Care and Cleaning , page 32, General Cleaning Tips , second column, first bullet point).
	c. Worn	c. Replace gasket or adjust it (see Care and Cleaning , page 31, Rubber Gasket , third bullet point).
	3. Dented rim of lid and/or cooker body	Both lid and cooker body must be repaired by a Hawkins Authorised Service Centre (see Hawkins Authorised Free Service , page 88, and Directory of Hawkins Authorised Service Centres , page 89). To avoid denting, do not hit rim of cooker body or drop cooker body/lid.
	4. Safety valve is fused	Replace safety valve with a genuine Hawkins safety valve (see Parts, Do-It-Yourself Repairs and Service , pages 84–89).

If This Happens...	Causes	Solutions
F. Hard Anodising Lightens or is Worn Off on Inside Base	Note: Lightening and wearing off of hard anodising cannot be restored and will not affect the functioning of the cooker and cooking result; follow the three Solutions below to prevent further damage.	
	1. Scouring with abrasive plastic scrubbers, steel wool or cleaning powder, ash, bleach or soda	Wash only with non-abrasive cleaning products.
	2. Washing in dishwasher	Hand wash. Do not put in a dishwasher.
	3. Deposits of salts and minerals in water	Wash and wipe dry cooker after every use.
G. Base of Pressure Cooker is No Longer Flat	1. Overheating, boiling dry 2. Putting hot cooker in water 3. Long term use	Can be repaired only by a Hawkins Authorised Service Centre (see Directory of Hawkins Authorised Service Centres , page 89).
H. Yellow or Brownish Stains in Base of Cooker	Food stains accumulate because cooker not washed properly after every use	Rub stains with a non-abrasive cleaning powder such as 'Vim', a non-abrasive plastic scrubber and a little water. To prevent such stains, wash cooker properly after every use.
I. Food Spills from Separator Set While Cooking	1. Too much food in container	Reduce quantity of food and/or liquid. See Maximum Quantities of Various Foods for the Hawkins Separator Sets , page 27.
	2. Too much water in base of cooker and water boils into container	Follow the water quantity to be put in cooker body given in Maximum Quantities of Various Foods for the Hawkins Separator Sets , page 27.

Measurements

Volume		Abbreviations	
All measurements are level, not heaped. Measurements of ghee in the recipes are for ghee at room temperature.		Abbreviation	Equivalent
Measurement	Equivalent	tsp	teaspoon
1 teaspoon	5 ml	tbsp	tablespoon
1/2 tablespoon	1 1/2 teaspoons / 7.5 ml	ml	millilitre
1 tablespoon	3 teaspoons / 15 ml	g	gram
1/4 cup	4 tablespoons / 60 ml	kg	kilogram
1/3 cup	5 tablespoons + 1 teaspoon / 80 ml	kgf	kilogram force
1/2 cup	8 tablespoons / 120 ml	mm	millimetre
3/4 cup	12 tablespoons / 180 ml	cm	centimetre
1 cup	16 tablespoons / 240 ml	°C	degree centigrade
1 litre	1000 ml		
Length			
Measurement	Equivalent		
1/4 inch	6 mm		
1/2 inch	1.3 cm		
3/4 inch	1.9 cm		
1 inch	2.5 cm		

Maximum Cooking Capacities/Volumes for Different Sizes of Hawkins

As explained in **Getting to Know Your Hawkins**, page 9, the pressure cooker body should never be filled with food and water combined to more than two-thirds capacity. Certain foods should be filled to half or one-third capacity. The volumes of the two-thirds, half and one-third capacities are given in the chart below.

Size of Cooker	Capacity in Cups			Capacity in Litres/ml		
	Two-Thirds	Half	One-Third	Two-Thirds	Half	One-Third
1.5 Litre	4	3	2	1 litre	750 ml	500 ml
2 Litre	5 $\frac{1}{2}$	4	2 $\frac{3}{4}$	1.3 litres	1 litre	660 ml
3 Litre	8 $\frac{1}{3}$	6 $\frac{1}{4}$	4	2 litres	1.5 litres	1 litre
3.5 Litre	9 $\frac{3}{4}$	7 $\frac{1}{3}$	5	2.3 litres	1.8 litres	1.2 litres
4 Litre	11	8 $\frac{1}{3}$	5 $\frac{1}{2}$	2.7 litres	2 litres	1.3 litres
5 Litre	14	10 $\frac{1}{2}$	7	3.3 litres	2.5 litres	1.7 litres
6.5 Litre	18	13 $\frac{1}{2}$	9	4.3 litres	3.3 litres	2.2 litres
8 Litre	22	16 $\frac{2}{3}$	11	5.3 litres	4 litres	2.7 litres
10 Litre	27 $\frac{3}{4}$	20 $\frac{3}{4}$	13 $\frac{3}{4}$	6.7 litres	5 litres	3.3 litres
12 Litre	33 $\frac{1}{3}$	25	16 $\frac{2}{3}$	8 litres	6 litres	4 litres

Choose the Cooker Size to Suit Your Needs

Choose the right size of cooker based on the number of persons you wish to serve.

Size of Cooker	Number of Persons
1.5 Litre	1 or 2
2 Litre	2 or 3
3 Litre	3 or 4
3.5 Litre	4 or 5
4 Litre	4 to 6
5 Litre	5 to 7
6.5 Litre	7 to 9
8 Litre	8 to 11
10 Litre	10 to 14
12 Litre	12 to 16

PRESSURE COOKING CHARTS

You may need to modify some of the pressure cooking times when cooking food from different regions.

Cooking Rice

The basic steps to pressure cook rice are:

1. Pour water in cooker. Bring to boil on high heat. Add rice and seasonings (if desired). Stir. It is also possible to add rice, water and seasoning all together in the beginning.
2. Close cooker. Bring to full pressure on high heat. Reduce heat and cook the required time.
3. Remove cooker from heat. Release pressure according to the chart.
4. Open cooker. Fluff up rice gently with a fork to separate grains.

There are many varieties of rice and some amount of experimentation with water and cooking time may be necessary to suit your taste.

- Do not fill cooker more than half.
- The grid is not required unless cooking rice in a mold/container.
- Pick over rice to remove foreign objects. Wash rice by rinsing in water until water is clear. Drain.

- Various stocks, spices and flavourings may be added to rice.
- When frying rice, stir gently with a wooden spoon to avoid breaking the grains.
- 1 cup of dry rice yields 2 to 3 cups cooked rice.
- Some varieties of rice, especially white rice, froth out of the vent tube unless they are cooked with oil or butter or in a mold.

To pressure cook Basmati rice in a mold, such as a metal bowl:

1. Put 1 cup/200 g rice and $1\frac{1}{8}$ cups/270 ml water in a mold (large enough to hold $3\frac{1}{2}$ cups/840 ml).
2. Pour 1 cup/240 ml water in cooker. Put grid in cooker. Place mold on grid.
3. Close cooker. Bring to full pressure on high heat. Reduce heat and cook 3 minutes.
4. Remove cooker from heat. Allow to cool naturally 5 minutes. Release pressure with slight lifting of vent weight.
5. Open cooker.

Rice Pressure Cooking Chart

Size of Cooker	Rice	Maximum Quantities				Water Quantity per cup of Rice		Pressure Cooking Time in Minutes	Pressure Release
		In Cups		In g/kg, ml/Litres		Cups	ml		
		Rice	Water	Rice	Water				
1.5 Litre	Colam Rice	1	1 ¹ / ₃	200 g	320 ml	–	–	2	Allow to cool naturally
	Basmati Rice	1	1 ¹ / ₄	200 g	300 ml	–	–	3	Allow to cool 5 minutes and release pressure
	Parboiled Rice	¾	1 ¹ / ₄	150 g	300 ml	–	–	7	Allow to cool naturally
2 Litre	Colam Rice	1 ¹ / ₄	1 ² / ₃	250 g	400 ml	1 ¹ / ₄	300 ml	2	Allow to cool naturally
	Basmati Rice	1 ¹ / ₄	1 ² / ₃	250 g	400 ml	1 ¹ / ₈	270 ml	3	Allow to cool 5 minutes and release pressure
	Parboiled Rice	1	1 ² / ₃	200 g	400 ml	–	–	7	Allow to cool naturally
3 Litre	Colam Rice	2	2	400 g	480 ml	1 ¹ / ₄	300 ml	2	Allow to cool naturally
	Basmati Rice	2	2	400 g	480 ml	1 ¹ / ₈	270 ml	3	Allow to cool 5 minutes and release pressure
	Parboiled Rice	1 ³ / ₄	2 ³ / ₄	350 g	660 ml	1 ² / ₃	400 ml	7	Allow to cool naturally
3.5 Litre	Colam Rice	3	4	600 g	960 ml	1 ¹ / ₄	300 ml	2	Allow to cool naturally
	Basmati Rice	3	3 ¹ / ₂	600 g	840 ml	1 ¹ / ₈	270 ml	3	Allow to cool 5 minutes and release pressure
	Parboiled Rice	2 ³ / ₄	4 ¹ / ₂	550 g	1.1 litres	1 ² / ₃	400 ml	7	Allow to cool naturally
4 Litre	Colam Rice	3 ¹ / ₂	4 ¹ / ₂	700 g	1.1 litres	1 ¹ / ₄	300 ml	2	Allow to cool naturally
	Basmati Rice	3 ¹ / ₂	4	700 g	960 ml	1 ¹ / ₈	270 ml	3	Allow to cool 5 minutes and release pressure
	Parboiled Rice	3	5	600 g	1.2 litres	1 ² / ₃	400 ml	7	Allow to cool naturally

Chart continued overleaf

Rice Pressure Cooking Chart

Size of Cooker	Rice	Maximum Quantities				Water Quantity per cup of Rice		Pressure Cooking Time in Minutes	Pressure Release
		In Cups		In g/kg, ml/Litres		Cups	ml		
		Rice	Water	Rice	Water				
5 Litre	Colam Rice	4 ¹ / ₂	5 ¹ / ₂	900 g	1.3 litres	1 ¹ / ₄	300 ml	2	Allow to cool naturally
	Basmati Rice	4 ¹ / ₂	5	900 g	1.2 litres	1 ¹ / ₈	270 ml	3	Allow to cool 5 minutes and release pressure
	Parboiled Rice	4	6 ¹ / ₂	800 g	1.6 litres	1 ² / ₃	400 ml	7	Allow to cool naturally
6.5 Litre	Colam Rice	5	6	1 kg	1.4 litres	1 ¹ / ₄	300 ml	2	Allow to cool naturally
	Basmati Rice	5	5 ¹ / ₂	1 kg	1.3 litres	1 ¹ / ₈	270 ml	3	Allow to cool 5 minutes and release pressure
	Parboiled Rice	5	8 ¹ / ₃	1 kg	2 litres	1 ² / ₃	400 ml	7	Allow to cool naturally
8 Litre	Colam Rice	6	7 ¹ / ₄	1.2 kg	1.7 litres	1 ¹ / ₄	300 ml	2	Allow to cool naturally
	Basmati Rice	6	7 ¹ / ₄	1.2 kg	1.7 litres	1 ¹ / ₈	270 ml	3	Allow to cool 5 minutes and release pressure
	Parboiled Rice	6	9 ¹ / ₂	1.2 kg	2.3 litres	1 ² / ₃	400 ml	7	Allow to cool naturally
10 Litre	Colam Rice	7 ¹ / ₂	9	1.5 kg	2.2 litres	1 ¹ / ₄	300 ml	2	Allow to cool naturally
	Basmati Rice	7 ¹ / ₂	9	1.5 kg	2.2 litres	1 ¹ / ₈	270 ml	3	Allow to cool 5 minutes and release pressure
	Parboiled Rice	7 ¹ / ₂	12	1.5 kg	2.9 litres	1 ² / ₃	400 ml	7	Allow to cool naturally
12 Litre	Colam Rice	10	13 ¹ / ₃	2 kg	3.2 litres	1 ¹ / ₄	300 ml	2	Allow to cool naturally
	Basmati Rice	9	10 ³ / ₄	1.8 kg	2.6 litres	1 ¹ / ₈	270 ml	3	Allow to cool 5 minutes and release pressure
	Parboiled Rice	11	17 ² / ₃	2.2 kg	4.2 litres	1 ² / ₃	400 ml	7	Allow to cool naturally

Cooking Dal

The basic steps to pressure cook *dal* are:

1. Put *dal*, water and seasonings (if desired) in cooker. Stir.
2. Close cooker. Bring to full pressure on high heat. Reduce heat and cook the required time.
3. Remove cooker from heat. Allow to cool naturally.
4. Open cooker. Add tempering with spices as desired.

Some *dal* such as *tuvar*, *chana*, *moong* and *urad dal* tend to sprout while cooking. Pressure cooking these *dal* in a mold eliminates sprouting.

For example, $\frac{3}{4}$ cup/150 g *tuvar dal* and 2 cups/480 ml water may be pressure cooked in a 1 litre mold on the grid. Water in cooker body: 1 cup/240 ml water. Pressure cooking time: 10 minutes. Yield: 2 $\frac{1}{2}$ cups. See **Using Grids, Separator Sets, Idli Stands and Molds**, pages 29 and 30, **Using Molds**.

See the following suggestions to reduce sprouting when cooking dal directly in the cooker.

To Reduce *Dal* Sprouting

1. **Do not** fill the cooker body (*dal* and water combined) to more than one-third. Do not exceed *dal* and water quantities and cooking times given in the following chart.
2. **Do** soak *dal* (in enough water to cover *dal*) for 15 minutes before pressure cooking and add 1 tsp/5 ml salt, *plus* $\frac{1}{4}$ tsp/1.3 ml turmeric *plus* 1 tsp/5 ml vegetable oil per cup of *dal*, to *dal* and water in cooker. Stir. Close cooker.
3. **Do** reduce heat to medium or lower immediately when the pressure cooker reaches FOP (Full Operating Pressure).
4. **Do not** release pressure by lifting the vent weight. Allow to cool naturally.
5. If sprouting persists, bring to full pressure on medium heat and reduce heat immediately when the pressure cooker reaches FOP (Full Operating Pressure).

There are many varieties of *dal* and some amount of experimentation with water and cooking time may be necessary to suit your taste. A few examples are given in the charts overleaf.

Dal Pressure Cooking Chart

Size of Cooker	Dal *	Maximum Quantities				Pressure Cooking Time in Minutes (soaked or unsoaked)	Pressure Release
		In Cups		In g/kg, ml/Litres			
		Dal	Water	Dal	Water		
1.5 Litre	Tuvar dal	1/4	2/3	50 g	160 ml	5	Allow to cool naturally
	Moong dal	Do not cook this dal in this size of cooker					
2 Litre	Tuvar dal	1/3	3/4 cup + 2 tbsp	70 g	210 ml	4	Allow to cool naturally
	Moong dal	Do not cook this dal in this size of cooker					
3 Litre	Tuvar dal	3/4	2	150 g	480 ml	3	Allow to cool naturally
	Moong dal	Do not cook this dal in this size of cooker					
3.5 Litre	Tuvar dal	1	2 3/4	200 g	660 ml	1	Allow to cool naturally
	Moong dal	1/2	1 1/4	100 g	300 ml	1	Allow to cool naturally
4 Litre	Tuvar dal	1	2 3/4	200 g	660 ml	1	Allow to cool naturally
	Moong dal	3/4	2	150 g	480 ml	1	Allow to cool naturally
5 Litre	Tuvar dal	1 3/4	4 3/4	350 g	1.1 litres	1	Allow to cool naturally
	Moong dal	1 1/2	3 3/4	300 g	900 ml	1	Allow to cool naturally
6.5 Litre	Tuvar dal	2 1/4	6 1/2	450 g	1.6 litres	1	Allow to cool naturally
	Moong dal	2	5	400 g	1.2 litres	0 (Do not soak)	Allow to cool naturally
8 Litre	Tuvar dal	5	14	1 kg	3.4 litres	1	Allow to cool naturally
	Moong dal	2 1/3	5 3/4	470 g	1.4 litres	0 (Do not soak)	Allow to cool naturally

* To reduce sprouting: Soak 15 minutes in water and drain; add salt, turmeric and oil as specified in **To Reduce Dal Sprouting**, page 45.

Dal Pressure Cooking Chart

Size of Cooker	Dal *	Maximum Quantities				Pressure Cooking Time in Minutes (soaked or unsoaked)	Pressure Release
		In Cups		In g/kg, ml/Litres			
		Dal	Water	Dal	Water		
10 Litre	Tuvar dal	6 ¹ / ₄	18	1.2 kg	4.3 litres	1	Allow to cool 10 minutes and release pressure by placing cooker in up to 4 inches/ 10 cm of cold water in a basin or in a sink for a few minutes
	Moong dal	3	7 ¹ / ₂	600 g	1.8 litres	0 (Do not soak)	
12 Litre	Tuvar dal	7 ¹ / ₂	21	1.5 kg	5 litres	1	
	Moong dal	3 ¹ / ₂	8 ³ / ₄	700 g	2.1 litres	0 (Do not soak)	

* To reduce sprouting: Soak 15 minutes in water and drain; add salt, turmeric and oil as specified in **To Reduce Dal Sprouting**, page 45. For *Moong dal* in 6.5 Litre, 8 Litre, 10 Litre and 12 Litre do not soak but follow all the other steps stated herein above.

Cooking Legumes (Pulses)

Legumes are cholesterol-free, low in fat and high in proteins, minerals, B vitamins and fibre. They are particularly valuable for vegetarians and those wishing to reduce meat consumption. Legumes tend to foam while cooking. This can be messy and/or block the vent tube unless you FOLLOW THE INSTRUCTIONS GIVEN IN THIS SECTION.

Precautions

- Never fill cooker more than half. If frothing occurs, reduce quantity to one-third. Legumes expand when cooked and absorb water. Do not reduce water quantity below 1½ cups.
- Measure legumes. Pick over to remove stones, dirt and shriveled, broken pieces and wash before cooking. To wash: place legumes in a bowl. Cover with water and agitate gently. Remove and discard floating pieces. Tip bowl to one side to drain off water, keeping one hand on the edge of the bowl to prevent legumes spilling. Repeat several times.
- Most varieties of beans yield about 2½ cups cooked beans for every 1 cup dry beans.

Soaking Legumes

You may or may not soak most legumes before pressure cooking. Soaked legumes cook more evenly, more quickly and may taste better. Soaking legumes and then discarding the soaking water can reduce

the water soluble complex sugars which may cause the discomfort some people experience digesting legumes. If you soak legumes, adding 1 tablespoon of vegetable oil for each cup of legumes while pressure cooking helps reduce frothing. Unsoaked legumes froth less and hold their shape better. Some legumes also retain more of their colour when unsoaked. Two methods of soaking are:

1. To soak overnight (about 8–10 hours): Put legumes in double their volume (enough to cover) of cold water overnight.
2. To "quick soak" one hour: Put legumes in a pan. Pour over legumes 3-4 cups of water for every 1 cup of legumes. Bring to rapid boil; boil 2 minutes. Remove from heat. Cover the pan and allow to stand 1 hour.

Drain and rinse legumes. Remove any floating, loose skins before cooking.

Pressure Cooking Legumes

1. Put legumes and water in cooker. The grid is not required. A standard proportion is 3 cups of water for every 1 cup of legumes. The quantity of water can be reduced or increased according to your experience. Be sure the legumes are well covered with water. Legumes absorb water while cooking. **Do not fill cooker more than half.**

2. Adding 1 tablespoon of vegetable oil for every cup of legumes helps reduce frothing – especially with soaked beans. Add 2 tablespoons of oil for every 1 cup of soybeans. Salt and acidic foods such as tomatoes, ketchup, lemon juice, vinegar and molasses cause the skins of the beans to harden and extend the cooking times substantially. These are not ordinarily added while cooking. You may add flavourings such as 1 clove garlic (minced or whole), 1 bay leaf and/or a whole onion, according to your taste.

3. Boil. Skim off any scum with a slotted spoon. Close cooker. **Bring to full pressure on medium heat. Reduce heat immediately when full pressure has been reached to prevent frothing.** Remove cooker briefly from heat if the steam seems to be evacuating too forcefully. Heat should be the minimum necessary to maintain pressure.

4. Time according to the chart. The times given are approximate – the variety of legume, freshness and growing conditions affect cooking time. Beans should be cooked until they can be squeezed with thumb and finger or mashed with your tongue against the roof of your mouth quite easily. Cook until ALL the legumes are cooked: do not eat legumes which are undercooked. The times given in the chart are for "just cooked" legumes. Cook longer when softer legumes are required, as for purées and soups.

5. When cooking is complete, remove cooker from heat and allow to cool naturally or place cooker in 1½ inches/ 4 cm to 4 inches/10 cm of cold water (depending upon the size of the cooker) in a basin or in a sink for a few minutes. **NEVER release pressure by lifting the vent weight.** Open cooker. Check doneness. If necessary, bring back to pressure and cook more or simmer without the lid until done. We do not recommend bringing soybeans back to pressure as they tend to froth out of the vent tube. Drain.

Legumes (Pulses) Pressure Cooking Chart

Legume (1 cup)	Pressure Cooking Time in Minutes		<ul style="list-style-type: none"> ● For each item: Water: 3 cups. Allow to cool naturally. ● Always ensure there is enough water to last the entire pressure cooking time. See Cooking Tips, page 20, Water. ● The maximum quantities for some of the smaller sizes is less than 1 cup. Cook only the soaked or unsoaked quantities as prescribed in the chart below. ● For 3 Litre: Do not exceed the 1 cup quantity given in the chart alongside.
	Soaked	Unsoaked	
Black-eyed Beans (Lobia)	6	15	
Chickpeas (Kabuli Chana)	12	48	
Kidney Beans (Rajma)	11	40	
Lentils (Sabat Masoor)	Do not soak	6	
Moong Beans	Do not soak	8	
Soybeans (Add 2 tablespoons vegetable oil to reduce frothing)	25	50	

Maximum Quantities for the 1.5 Litre and 2 Litre Pressure Cookers

Legume	1.5 Litre				2 Litre			
	$\frac{1}{2}$ Cup Legume quantity							
	Soaked		Unsoaked		Soaked		Unsoaked	
	Water (cups)	PCT* (Minutes)	Water (cups)	PCT* (Minutes)	Water (cups)	PCT* (Minutes)	Water (cups)	PCT* (Minutes)
Black-eyed Beans (Lobia)	$1\frac{1}{2}$	6	$1\frac{3}{4}$	15	$1\frac{1}{2}$	6	$2\frac{1}{2}$	15
Chickpeas (Kabuli Chana)	$1\frac{1}{2}$	12	Do not cook		$1\frac{1}{2}$	12	3	48
Kidney Beans (Rajma)	$1\frac{1}{2}$	11	Do not cook		2	11	3	40
Lentils (Sabat Masoor)	Do not soak		$1\frac{1}{2}$	6	Do not soak		$2\frac{3}{4}$	6
Moong Beans	Do not soak		$1\frac{1}{2}$	8	Do not soak		$2\frac{3}{4}$	8
Soybeans	$1\frac{1}{2}$	25	Do not cook		2	25	$2\frac{1}{4}$	50

* PCT = Pressure Cooking Time

Vegetable Pressure Cooking Chart

Vegetable	Description		Water in Pressure Cooker	Pressure Cooking Time in Minutes
Asparagus	Tough ends removed		1/2 cup	1-2 depending on size
Beets	Whole unpeeled, root and 2.5 cm of stem remaining	small	1 cup	10
		medium	1 1/2 cups	12-16 depending on size
Broccoli	Flowerettes		1/2 cup	1
	Full stalks stems scored		1/2 cup	2
Brussels Sprouts	Whole ends trimmed		1 cup	3
Cabbage	Quartered		1 cup	5-6 depending on size
Carrots	Sliced (foil on grid)		1/2 cup	1
	Whole baby or large cut into halves lengthwise		1/2 cup	2
	Whole		1 cup	4-7 depending on size
Cauliflower	Flowerettes		1/2 cup	2
	Whole small stems and leaves removed, core hollowed		1 cup	5
Corn on the Cob	Whole		1 cup	4-5 depending on size and tenderness
Eggplant/Brinjal	Cut into 1.5 cm slices		1/2 cup	0
Green Beans	Whole ends trimmed		1/2 cup	1-2 depending on tenderness
	Cut into 2.5 cm pieces		1/2 cup	0-1 depending on tenderness

Note: NEVER reduce water quantity. Also, see notes on page 52.

Chart continued overleaf

Vegetable Pressure Cooking Chart

Vegetable	Description		Water in Pressure Cooker	Pressure Cooking Time in Minutes
Kohlrabi	Cut into 1.5 cm slices		1 cup	4
Mustard Greens	Stalks removed		1/2 cup	2
Onions	Whole small		1 cup	5
Peas	Shelled (foil on grid)	small	1/2 cup	1
		medium	1/2 cup	2
Potatoes	Cut into 1.5 cm slices		1/2 cup	2
	Peeled and cut into 4 cm pieces		1 cup	6
	Whole peeled or unpeeled	small (85 g)	1 cup	10
		medium (100 g)	1 1/2 cups	15
Spinach	Stalks removed		1/2 cup	0
Sweet Potatoes	Halved lengthwise		1 cup	6-8 depending on size
Yam	Cut into 2.5 cm x 2.5 cm x 1.5 cm pieces		1 cup	3

- For each item: Use grid, NEVER reduce water quantity and release pressure immediately.
- The times given were developed using a moderate amount of vegetables on a grid in a 5 Litre pressure cooker. When cooking in a pressure cooker larger than 5 Litre, where the recommended water quantity is 1/2 cup (for a maximum of 2 minutes pressure cooking time), increase water to 1 cup.
- Times given in the chart are for fresh vegetables. For old and tough vegetables, increase zero pressure cooking time up to 1 minute, other times up to double.
- When pressure cooking vegetables with short pressure cooking times of 0 to 2 minutes and 1/2 cup water do not leave the cooker once it is on heat. Pressure cook without delays: time accurately, remove cooker from heat quickly and release pressure immediately.

Seafood Pressure Cooking Chart

<i>Seafood</i>	<i>Shape and Size</i>	<i>Water in Pressure Cooker*</i>	<i>Pressure Cooking Time in Minutes</i>
Baby Shark (Mori)	Pieces 2.5 cm thick	¾ cup	3
Indian Herring (Hilsa)	Pieces 2.5 cm thick	¾ cup	2
Indian Salmon (Rawas)	Pieces 2.5 cm thick	¾ cup	3
Mackerel (Bangda)	Whole	¾ cup	3
Pomfret (Paplet)	Pieces 2.5 cm thick	¾ cup	2
Prawns (Jhinga)	Medium , shelled, de-veined	¾ cup	3
Seer fish (Surmai)	Pieces 2.5 cm thick	¾ cup	3
South Asian Carp (Rohu)	Pieces 2.5 cm thick	¾ cup	2

- For each item: Use grid and release pressure immediately.
- The times given were developed using a moderate amount of seafood on a grid in a 5 Litre pressure cooker. When cooking in a pressure cooker larger than 5 Litre, where the recommended water quantity is ¾ cup, increase water by ½ cup to 1¼ cups. When deciding the water quantity, keep in mind that some fish give off juices.
- When pressure cooking seafood, even a few extra seconds can overcook. Do not leave the cooker once it is on the heat – cooking times are so short. Pressure cook seafood without delays: time accurately, remove cooker from heat quickly and release pressure immediately.

* NEVER reduce water quantity. ●

Cooking Meat and Poultry

- Cooking time is affected by the thickness, the cut, the quality, the preparation (boneless, rolled etc.) of the meat and personal preference. The smaller the piece of meat, the greater its tenderness, the higher the quality and the bigger the bone – the shorter the cooking time required. Meat varies widely from region to region. The times given in the chart and recipes are for specific cuts and should serve as guides to be modified according to your ingredients, experience and taste.
- The pressure cooking time for large pieces of meat, called roasts, is according to weight – minutes of cooking per kg of meat. The shape and thickness of the roast affect the cooking time. Short, fat roasts take longer to cook than long, flat roasts. Boneless and rolled roasts take longer to cook than roasts with bones. Allow enough space around the roast in the cooker for steam circulation to ensure even cooking. For a more "roasted" effect, cook roast on grid.
- All the times in the **Poultry Pressure Cooking Chart** except turkey are for poultry which has been lightly browned. The amount of browning can affect the cooking time – the less the browning, the longer the pressure cooking time. You may have to adjust the cooking time to reflect the degree of browning you prefer.
- Cooking times in the Poultry Pressure Cooking Chart are based on medium-sized pieces of young poultry. Increase time when cooking larger and/or older pieces.

Note: The times given were developed using a moderate amount of vegetables on a grid in a 5 Litre pressure cooker. When cooking in a pressure cooker larger than 5 Litre, increase the water quantity according to the cooker size, the quantity and type of food. See **Recipes**, pages 55–57. When deciding the water quantity, keep in mind that some meat or poultry give off juices.

Meat Pressure Cooking Chart				
Meat	Description	Use Grid?	Water in Pressure Cooker	Pressure Cooking Time in Minutes
Lamb	Leg	Yes	1 cup	11 per 450 g
	Shank about 450 g	No	1½ cups	30
	Shoulder Chops 2.5 cm thick	Yes	1 cup	18
	Stew Meat (shoulder) 4 cm cubes	No	1 cup	10-12
Method of Pressure Release: Allow to cool naturally				

Poultry Pressure Cooking Chart				
Poultry	Description	Use Grid?	Water in Pressure Cooker	Pressure Cooking Time in Minutes
Chicken	Pieces	Yes	1 cup	7
		Yes	1 cup	9
	Whole Fryer (1.4 kg)	No	1 cup	11
Duck	Pieces	No	1 cup	13-15
Turkey	Breast half (1.1 kg)	Yes	1 cup	28
	Thigh	No	1 cup	20
	Leg	No	1 cup	20
Method of Pressure Release: Allow to cool naturally				

RECIPES

This section contains 20 recipes – five each from the North, South, East and West of India. **These recipes have been written for the 5 Litre Hawkins Pressure Cookers.**

Adjusting the Recipes for Pressure Cooker Sizes Other than 5 Litre

To achieve the original result from a recipe when reducing or increasing it depends on several factors: the recipe (type, ingredients, amount of cooking liquid and method), the cooker size and shape, the pressure cooking time and how much reducing or increasing is attempted. The more a recipe is reduced or increased the more adjustments may be required.

1. To adjust the following 7 recipes in this Manual to cooker sizes other than 5 Litre, reduce or increase all ingredients in the recipes as per the Adjustment Chart alongside without any other changes (pressure cooking times remain the same).

<i>Elumichham Pazham Saadham</i>	Mixed Vegetable Pulao
<i>Khichuri</i>	<i>Mansam Chops</i>
<i>Kozhi Koottaan</i>	<i>Vatanyachi Usal</i>
<i>Lapsi</i>	

Adjustment Chart

Size of Cooker	To Adjust Recipes...	
1.5 Litre	Reduce by	70%
2 Litre		60%
3 Litre		40%
3.5 Litre		30%
4 Litre		20%

Size of Cooker	To Adjust Recipes...	
6.5 Litre	Increase by	30%
8 Litre		60%
10 Litre		100%
12 Litre		140%

2. The remaining 13 recipes in this Manual require additional adjustments to those in point 1 alongside and these are given with the recipes. Unless otherwise indicated, these 13 recipes can be reduced or increased proportionately in the amounts given in the Adjustment Chart above and pressure cooking times remain the same.

3. The percentages given in the Adjustment Chart are connected to the size of the cooker. They do not necessarily apply to other sizes. For example, the chart indicates a 70% proportionate reduction for *Ma ki Dal* in a 1.5 Litre cooker and the recipe additionally states to reduce water quantity by 60%. This same quantity (recommended for a 1.5 Litre cooker) will not cook successfully in any cooker over 8 Litre. It will burn.

4. The recipes include cooking procedures other than pressure cooking. Some of the instructions for these cooking procedures give approximate cooking times to achieve a certain result. Adjust these cooking times as required to achieve the specified result. Larger quantities may take longer time and smaller quantities may take less time.

5. Whatever adjustments are made, do not fill the pressure cooker more than two-thirds full and half full with liquid or frothing food. See the chart on **Maximum Cooking Capacities/Volumes for Different Sizes of Hawkins**, page 41 for the maximum cooking capacities for each pressure cooker.

6. The maximum quantities for cooking several varieties of rice and *dal* in all different sizes, see **Rice Pressure Cooking Chart**, page 43 and **Dal Pressure Cooking Chart**, page 46.

7. Always ensure there is enough water/cooking liquid for the entire pressure cooking time. The Manual recipes have the water/cooking liquid for 5 Litre cookers and the adjustments for sizes other than 5 Litre are given as required. When pressure cooking without a recipe or a chart or your own proven dish, it is necessary to decide how much water/cooking liquid to use. This depends on a variety of factors

such as the pressure cooking time, size of the cooker, the food being cooked, the heat source and setting. General recommendations for water/cooking liquid when pressure cooking without a tested recipe or chart are given in **Cooking Tips**, page 20, **Water** along with five other related points.

General Tips on Adjusting Recipes

Reducing Quantities

(for 1.5 Litre, 2 Litre, 3 Litre, 3.5 Litre and 4 Litre)

- **Heat Source:** When cooking in 1.5 Litre, 2 Litre and 3 Litre cookers (except 3 Litre Wide), 4 Litre Contura and 4 Litre Contura Black, use the small burner or do not exceed the medium heat setting of a large burner.
- The 1.5 Litre, 2 Litre and 3 Litre cookers (except 3 Litre Wide) are small size pressure cookers. Careful and precise measurement of ingredients/water, proper control of heat and pressure cooking time will reduce the chances of frothing/sprouting and sticking/burning of food.
- Cooking *moong dal* and *urad dal* is not recommended in the 1.5 Litre, 2 Litre and 3 Litre cookers.
- NEVER reduce the water quantities given in the **Vegetable Pressure Cooking Chart** on pages 51 and 52 or the **Seafood Pressure Cooking Chart** on page 53.
- When reducing the quantity of ingredients in recipes with gravies, the quantity of cooking liquid may require less than a proportionate reduction. Since decreased tomatoes, onions, poultry, meat, fish

etc. give off less juices, a proportionate reduction in cooking liquid can result in a thicker gravy. You may adjust the consistency and quantity of gravy after pressure cooking.

- Recipes which combine beans or rice with other juicy foods may also require less than a proportionate reduction in cooking liquid when they are reduced. Beans and rice, however, absorb liquid and there must be enough to cook them. Such recipes may require some experimentation to determine the optimum quantity of cooking liquid.
- A general observation is that small cookers may require more cooking liquid than a proportionate reduction from the 5 Litre recipes and an increase in pressure cooking time. Examples may be seen in the information on Adjustments in some recipes.
- Most large pieces of meat, whole chicken, whole artichokes, whole cauliflowers, whole green peppers and whole tomatoes are too big to fit in the available space in the 1.5 Litre, 2 Litre, 3 Litre and 3.5 Litre cookers and 4 Litre Classic. The available space is the space from cooker base to the two-thirds level. When judging if an item or quantity of food will fit, include the height of the grid (1/2 inch/1.3 cm) if it is used.

Increasing Quantities (for the 6.5 Litre, 8 Litre, 10 Litre and 12 Litre)

- When increasing the quantity of ingredients in recipes with gravies, the quantity of cooking liquid may not require a proportionate increase. Since increased tomatoes, onions, poultry, meat, fish etc. give off juices, adding a proportionate increase in cooking

liquid can result in a diluted gravy. You may adjust the consistency and quantity of gravy after pressure cooking.

- Recipes which combine beans or rice with other juicy foods may also require less than a proportionate increase in cooking liquid when they are increased. Beans and rice, however, absorb liquid and there must be enough to cook them. Such recipes may require some experimentation to determine the optimum quantity of cooking liquid. We recommend cooking the quantity for the 5 litre pressure cooker to familiarise yourself with such recipes before attempting an increase.
- Do not cook large quantities of delicate vegetables such as cauliflower (if their appearance is important) as they can get crushed from the weight and become soggy. When cooking more than 1.4 kg of such vegetables, reduce the pressure cooking time to 0 minutes to compensate for the additional time the pressure cooker takes to come to pressure.
- Increase quantity for large pieces of meat and size of whole chicken appropriately such that it is convenient to brown and there is sufficient space around the meat or chicken in the cooker for steam circulation. Increase cooking time proportionate to the weight and size/thickness of the chicken/meat.
- Individual foods which cannot be stacked one on another may be increased to the extent the additional food can be accommodated on the grid.
- Increase salt after pressure cooking, according to taste.

Ma ki Dal **(Whole Black Gram)**

Yield: 7½ cups

Serves 8

Pressure Cooking Time 30 minutes

6½ cups / 1.6 litres

water

1¼ cups / 250 g

sabat urad soaked 30 minutes
and drained

¼ cup / 60 ml

rajma soaked 4 hours or
"quick soaked" 1 hour (see page 48)
and drained

2 medium (200 g)

tomatoes chopped

1 x 1.5 cm piece (5 g)

fresh ginger cut into thin strips

6 cloves

garlic chopped

2

green chillies chopped

1

whole dry Kashmiri red chilli
(see page 83)

1½ tbsp / 22.5 ml

salt

¼ tsp / 1.3 ml

red chilli powder

1 tbsp / 15 ml

ghee

Tempering

2 tbsp / 30 ml

ghee

1 small (50 g)

onion chopped

1 x 1.5 cm piece (5 g)

fresh ginger finely chopped

¼ tsp / 1.3 ml

red chilli powder

1. Pour water in cooker. Bring to boil on high heat. Add remaining ingredients except those for Tempering. Stir.
2. Close cooker. Bring to full pressure on high heat. Reduce heat and cook 30 minutes.
3. Remove cooker from heat. Allow to cool naturally.
4. Open cooker. Partially mash *dal* with back of a ladle.
5. Place cooker with *dal* on low heat. Simmer till *dal* has a creamy consistency (about 5 minutes), stirring occasionally.
6. **Tempering:** In a pan, heat ghee on high heat about 1 minute. Add onion and stir fry till transparent. Add ginger and continue stir frying till onion is golden brown (see page 80, **Frying onions**). Remove pan from heat. Add chilli powder. Mix and pour evenly over *dal*. Serve hot. ●

Adjustments for other than 5 Litre: Adjust all ingredients proportionately except –

1. For 1.5 Litre: reduce water by 60%.
2. For 2 Litre: reduce water by 40%.

Matar Paneer (Cottage Cheese and Pea Curry)

Yield: 10 cups

Serves 8

Pressure Cooking Time 1 minute

1 x 2.5 cm piece (10 g)	fresh ginger
6 cloves	garlic
400 g	paneer cut into 2.5 cm cubes (see page 82)
1 cup / 240 ml	vegetable oil
4 medium (400 g)	onions grated
1 tsp / 5 ml	turmeric
1 tsp / 5 ml	red chilli powder
1½ tbsp / 22.5 ml	coriander powder
1 tbsp / 15 ml	cumin powder
1 tbsp / 15 ml	salt
2 large (350 g)	tomatoes chopped
2¾ cups / 660 ml	whey (see page 83) or water
5 cups / 750 g	peas shelled or frozen
½ tsp / 2.5 ml	garam masala powder (see page 80)
1 tbsp / 15 ml	coriander leaves chopped, lightly pressed into tbsp

1. Grind together ginger and garlic into a paste.
2. Group *paneer* into 3 batches. Heat oil in cooker on high heat about 3 minutes. Reduce heat to medium. Lightly brown each batch, stir frying gently, and remove. Remove cooker from heat. Allow to cool about 5 minutes. Remove oil. Strain. Measure ½ cup/120 ml of strained oil and put in cooker.
3. Place cooker with oil on high heat. Heat about 2 minutes. Add onions and stir fry till golden brown (see page 80, **Frying onions**). Add ginger-garlic paste. Stir a few seconds. Add turmeric, chilli, coriander and cumin powders, salt, tomatoes and ¼ cup/60 ml whey or water. Cook till tomatoes are pulpy and oil shows separately (about 5 minutes), stirring occasionally.
4. Add peas. Stir fry about 2 minutes. Add remaining whey or water (2½ cups/600 ml). Mix.
5. Close cooker. Bring to full pressure on high heat. Reduce heat and cook 1 minute.
6. Remove cooker from heat. Release pressure with slight lifting of vent weight.
7. Open cooker. Place cooker with peas on medium heat. Add *paneer*. Reduce heat to low and simmer about 5 minutes. Add *garam masala* powder. Mix.
8. Serve hot, garnished with coriander leaves. ●

Adjustments for other than 5 Litre: For 1.5 Litre and 2 Litre: increase pressure cooking time to 2 minutes.

Chana Pindi (Chickpeas – Rawalpindi Style)

Yield: 10 cups

Serves 8

Pressure Cooking Time 18 minutes

2 ¹ / ₂ tbsp / 37.5 ml	pomegranate seeds
2 tbsp / 30 ml	cumin seeds
4 cups / 960 ml	water
4 cups / 800 g	kabuli chana soaked overnight or in hot water for 2 hours and drained
2 ¹ / ₂ tbsp / 37.5 ml	salt
4	brown cardamoms
5 x 2.5 cm sticks	cinnamon
10	cloves
1/4 cup / 60 ml	coriander powder
2 tsp / 10 ml	garam masala powder (see page 80)
3 tbsp / 45 ml	mango powder
2 ¹ / ₂ tsp / 12.5 ml	pepper
3	green chillies slit (see page 81)
1 x 4 cm piece (15 g)	fresh ginger cut into thin strips
1/2 cup / 120 ml	vegetable oil

1/2 cup / 110 g	ghee
1 medium (100 g)	onion sliced into roundels
2	lemons cut into wedges

1. In a pan, roast together pomegranate and cumin seeds on medium heat (see page 82, **Roasting of spices**) and grind to a powder.
2. Pour water in cooker. Add *chana*, 1 tbsp + 1 tsp/20 ml salt, cardamoms, cinnamon and cloves. Stir.
3. Close cooker. Bring to full pressure on high heat. Reduce heat and cook 18 minutes.
4. Remove cooker from heat. Allow to cool naturally.
5. Open cooker. Drain off cooking liquid and reserve. Add pomegranate-cumin mixture, coriander, *garam masala* and mango powders, remaining salt (1 tbsp + 1/2 tsp/17.5 ml) and pepper. Mix till *chana* are evenly coated with spices. Sprinkle chillies and ginger on top.
6. In a pan, heat oil and ghee together on high heat about 3 minutes and pour evenly over *chana*. Add cooking liquid.
7. Place cooker with *chana* on medium heat and cook till liquid dries up and oil shows separately (about 10 minutes), stirring occasionally.
8. Remove cooker from heat. Put *chana* in a serving dish. Serve hot, garnished with onion and lemons. ●

Adjustments for other than 5 Litre: Adjust all ingredients proportionately except – for 1.5 Litre: in Step 2, add 1 tbsp/15 ml oil to reduce sprouting.

Rajma (Kidney Bean Curry)

Yield: 10 cups

Serves 8

Pressure Cooking Time 16 minutes

- | | |
|--|--|
| 1 x 2.5 cm piece (10 g) | fresh ginger |
| 12 cloves | garlic |
| 6 ¹ / ₄ cups + 1 tbsp / 1.5 litres | water |
| 2 ¹ / ₂ cups / 500 g | rajma soaked overnight or "quick soaked" 1 hour (see page 48) and drained |
| 1 tbsp + 2 tsp / 25 ml | salt |
| 1/2 cup / 120 ml | vegetable oil |
| 2 | whole dry Kashmiri red chillies (see page 83) |
| 2 large (300 g) | onions grated |
| 3 large (450 g) | tomatoes grated |
| 1/4 tsp / 1.3 ml | red chilli powder |
| 1 tsp / 5 ml | garam masala powder (see page 80) |
1. Grind together ginger and garlic into a paste, adding water (1 tbsp/15 ml) a little at a time.

2. Pour remaining water (6¹/₄ cups/1.5 litres) in cooker. Add *rajma* and 2¹/₂ tsp/12.5 ml salt. Stir.

3. Close cooker. Bring to full pressure on high heat. Reduce heat and cook 11 minutes*.

4. Remove cooker from heat. Allow to cool naturally.

5. Open cooker. Remove all cooking liquid. Measure and keep aside 4¹/₂ cups/1.1 litres of cooking liquid. (If it is less, add water to make it 4¹/₂ cups/1.1 litres. If it is more, keep the remaining cooking liquid** separately.) Take out *rajma* and keep separately. Wash and wipe dry cooker.

6. Heat oil in cooker on high heat about 2 minutes. Add chillies. Stir a few seconds. Add onions and stir fry till golden brown (see page 80, **Frying onions**). Add ginger-garlic paste. Stir a few seconds. Add tomatoes, chilli powder and remaining salt (2¹/₂ tsp/12.5 ml). Cook on high heat till oil shows separately (about 5 minutes), stirring occasionally. Add the reserved cooking liquid (4¹/₂ cups/1.1 litres). Mix.

7. Close cooker. Bring to full pressure on high heat. Reduce heat and cook 5 minutes.

* Some varieties of *rajma* may take longer to cook (up to double the time).

** If the gravy after pressure cooking is too thick, add remaining cooking liquid as desired.

8. Remove cooker from heat. Release pressure by placing cooker in up to 4 inches/10 cm of cold water in a basin or in a sink for a few minutes (see **Cooking Tips**, page 22, **Releasing Pressure**, point 3).

9. Open cooker. Add the reserved *rajma*.

10. Place cooker with *rajma* on high heat. Bring to boil, stirring and partially mashing *rajma* with back of a ladle to partially blend with liquid (about 3 minutes). Reduce heat to low. Simmer till gravy has a creamy consistency (about 10 minutes), stirring occasionally. Add *garam masala* powder. Mix. Serve hot. ●

Adjustments for other than 5 Litre: Adjust all ingredients proportionately except –

1. For 1.5 Litre: reduce all ingredients by 80%.
2. For 2 Litre: reduce all ingredients by 70%.

Gajar ka Halwa **(Carrot Pudding)**

Yield: 6 cups

Serves 8

Pressure Cooking Time 0 minute

10 large (1.8 kg) **carrots** grated

1/4 cup / 60 ml **milk**

2 cups / 400 g **sugar**

2²/₃ cups / 400 g **mava/khoya** crumbled
(see page 82)

1/4 cup + 3 tbsp / 90 g **ghee**

20 **almonds** blanched, skins
removed and sliced

1. Put carrots and milk in cooker.

2. Close cooker. Bring to full pressure on high heat. Remove cooker immediately from heat. Release pressure with slight lifting of vent weight. Open cooker.

3. Place open cooker with carrots and milk on high heat. Add sugar. Cook till liquid dries up (about 15 minutes), stirring occasionally. Add *mava/khoya* and ghee. Reduce heat to medium. Cook till ghee shows separately (about 10 minutes), stirring continuously. Serve hot, garnished with almonds. ●

Adjustments for other than 5 Litre: Adjust all ingredients proportionately except – do not reduce milk (1/4 cup/60 ml) at all when cooking reduced quantities.

Kozhi Koottaan (Chicken Curry – Kerala Style)

Yield: 10 cups

Serves 8

Pressure Cooking Time 7 minutes

1½ tsp / 7.5 ml
 1 tbsp + 1 tsp / 20 ml
 1 tbsp / 15 ml
 1.5 kg

 2½ cups / 200 g
 2¼ cups / 540 ml
 ¼ cup / 60 ml
 3
 3
 1 x 2.5 cm piece (10 g)
 16 cloves
 ½ tsp / 2.5 ml
 1 tsp / 5 ml
 2 x 2.5 cm sticks

turmeric
salt
curd
chicken pieces (legs cut into thighs and drumsticks; breasts cut in half lengthwise, each half cut crosswise into three pieces about 5 cm wide)
coconut coarsely grated
water
coconut oil
whole dry Kashmiri red chillies (see page 83)
whole dry red chillies
fresh ginger chopped
garlic
peppercorns
aniseed
cinnamon

10 **cloves**3 **green cardamoms** seeds taken out and kept, pods discarded¼ cup + 1 tbsp / 25 g **coriander seeds**½ tsp / 2.5 ml **cumin seeds**2 medium (250 g) **onions** chopped1 **green chilli** slit (see page 81)2 medium (200 g) **tomatoes** puréed (see page 82)

1. In a bowl, put 1 tsp/5 ml turmeric, 1 tsp/5 ml salt and curd. Mix. Add chicken. Mix. Keep aside.

2. Use coconut and 1 cup/240 ml water to make 1 cup/240 ml **thick coconut milk** (see page 79, **Coconut milk**). Keep aside. Remove remaining coconut from cloth. Use remaining coconut and ¾ cup/180 ml water to make ¾ cup/180 ml **thin coconut milk**. Keep aside.

3. In a pan, heat 1 tbsp/15ml coconut oil on medium heat about 30 seconds. Add whole dry Kashmiri red chillies, whole dry red chillies, ginger, garlic, peppercorns, aniseed, cinnamon, cloves, cardamoms, coriander and cumin seeds and roast (see page 82, **Roasting of spices**). Grind cooled roasted mixture into a paste, adding water (½ cup/120 ml) a little at a time.

4. Heat remaining oil (3 tbsp/45 ml) in cooker on high heat about 2 minutes. Add onions and stir fry till golden brown (see page 80, **Frying onions**).

Kozhi Koottaan**(Chicken Curry – Kerala Style)** *continued*

5. Add remaining turmeric (1/2 tsp/2.5 ml), ground paste, chilli and tomatoes. Cook about 3 minutes, stirring continuously. Add chicken and remaining salt (1 tbsp/15 ml). Mix. Add thin coconut milk. Stir.

6. Close cooker. Bring to full pressure on high heat. Reduce heat and cook 7 minutes.

7. Remove cooker from heat. Allow to cool naturally.

8. Open cooker. Add thick coconut milk. Stir. Serve hot. ●

Sambar**(Split Skinned Red Gram and Vegetable Curry – Tamil Style)**

Yield: 8 cups

Serves 8

Pressure Cooking Time 4 minutes

1/4 cup + 1 tbsp / 25 g

tamarind seeds removed before measuring

1 cup / 240 ml

hot water

1 1/2 tbsp / 22.5 ml

vegetable oil

2

whole dry Kashmiri red chillies (see page 83)

3

whole dry red chillies

1 tbsp / 15 ml

chana dal

1 x 1 cm piece

asafoetida

1/2 cup / 40 g

coconut grated

2 sprigs

curry leaves

1/4 cup / 60 ml

coriander seeds

1/2 tsp / 2.5 ml

cumin seeds

1/2 tsp / 2.5 ml

fenugreek seeds

5 1/2 cups / 1.3 litres

water

1 cup / 200 g

tuvar dal

1/2 tsp / 2.5 ml

turmeric

1 tbsp + 1 tsp / 20 ml

salt

1 medium (100 g)

onion cut lengthwise (top to bottom) into 6 pieces

2

drumsticks cut into 5 cm long pieces**Tempering**

2 tbsp / 30 ml

vegetable oil

1/2 tsp / 2.5 ml

mustard seeds

1. Extract tamarind pulp using 1 cup/240 ml hot water (see page 83, **To extract tamarind pulp**).

2. In a pan, heat oil on medium heat about 1 minute. Add whole chillies, *chana dal*, asafoetida, coconut, 1 sprig curry leaves, coriander, cumin and fenugreek seeds and roast (see page 82, **Roasting of spices**) till coconut turns light brown.

Elumichham Pazham Saadham *(Lime Rice – Tamil Style)*

Yield: 12 cups

Serves 8

Pressure Cooking Time 2 minutes

5 cups / 1.2 litres

4 cups / 800 g

1 tsp / 5 ml

1/2 cup / 120 ml

1 tsp / 5 ml

1 tbsp / 15 ml

1 tbsp / 15 ml

1 sprig

8

1 tbsp + 1³/₄ tsp / 23.8 ml

1/3 cup + 1 tbsp / 95 ml

water**colam rice****turmeric****vegetable oil****mustard seeds****chana dal****urad dal****curry leaves****green chillies** chopped**salt****lemon juice**

1. Pour water in cooker. Bring to boil on high heat. Add rice and turmeric. Stir.

2. Close cooker. Bring to full pressure on high heat. Reduce heat and cook 2 minutes.

3. Remove cooker from heat. Allow to cool naturally.

4. Open cooker. Lift rice gently with a fork to separate grains.

3. Grind cooled roasted mixture into a paste, adding water (1/2 cup/120 ml) a little at a time.

4. Pour 3 cups/720 ml water in cooker. Add *tuvar dal*, turmeric and salt. Stir.

5. Close cooker. Bring to full pressure on high heat. Reduce heat and cook 4 minutes.

6. Remove cooker from heat. Allow to cool naturally.

7. Open cooker. Mash *dal* completely with back of a ladle to blend with liquid. Add tamarind pulp, ground paste, onion, drumsticks, remaining curry leaves (1 sprig) and water (2 cups/480 ml). Stir.

8. Close cooker. Bring to full pressure on high heat. Remove cooker immediately from heat. Release pressure by placing cooker in up to 4 inches/10 cm of cold water in a basin or in a sink for a few minutes (see **Cooking Tips**, page 22, **Releasing Pressure**, point 3). Open cooker.

9. **Tempering:** In a pan, heat oil on medium heat about 1 minute. Add mustard seeds. When crackling, pour into *sambar*. Stir. Serve hot. ●

Adjustments for other than 5 Litre: Adjust all ingredients proportionately except –

1. For 1.5 Litre: reduce all ingredients by 80%.
2. For 2 Litre: reduce all ingredients by 70%.
3. For 1.5 Litre, 2 Litre and 3 Litre: in Step 5, increase pressure cooking time to 6 minutes.

Elumichham Pazham Saadham (Lime Rice – Tamil Style) *continued*

5. In a pan, heat oil on high heat about 2 minutes. Add mustard seeds. When crackling, add *chana dal* and *urad dal*. Reduce heat to medium. Stir fry till *dal* is light brown. Add curry leaves and chillies. Stir a few seconds and pour over rice.

6. In a small bowl, mix salt and lemon juice. Pour over rice. Mix. Serve hot. ●

Mansam Chops (Mutton Chops – Andhra Style)

Yield: 10¹/₂ cups

Serves 8

Pressure Cooking Time 10 minutes

1/2 cup / 40 g	coconut grated
1 x 10 cm piece (40 g)	fresh ginger
28 cloves	garlic
1 1/2 tbsp / 22.5 ml	peppercorns
5	green cardamoms seeds taken out and kept, pods discarded
8	cloves
2 x 2.5 cm sticks	cinnamon
1 tbsp + 1/2 tsp / 17.5 ml	cumin seeds
2/3 cup / 160 ml	water
1.2 kg	mutton chops 2.5 cm thick

2 medium (250 g)	tomatoes cut into quarters
1/2 tsp / 2.5 ml	turmeric
3/4 cup / 180 ml	vegetable oil
2 sprigs	curry leaves
3	green chillies cut crosswise into 1 cm pieces
1/4 cup / 60 ml	cashew nuts broken into pieces
4 medium (400 g)	onions sliced
1 1/2 tbsp / 22.5 ml	salt

1. Grind together coconut, ginger, garlic, peppercorns, cardamom seeds, cloves, cinnamon and cumin seeds into a paste, adding water (2/3 cup/160 ml) a little at a time.

2. Put chops, tomatoes and turmeric in cooker. Mix.

3. Close cooker. Bring to full pressure on high heat. Reduce heat and cook 10 minutes.

4. Remove cooker from heat. Allow to cool naturally.

5. Open cooker. Remove chops. Reserve cooking liquid.

6. In a large pan, heat oil on high heat about 3 minutes. Add curry leaves, chillies, cashew nuts and onions. Stir fry till onions are light golden brown (see page 80, **Frying onions**). Add ground paste. Stir fry about 3 minutes. Add cooking liquid and salt. Cook on high heat till liquid dries up and oil shows separately (about 5 minutes), stirring continuously. Add chops. Reduce heat to medium. Stir fry about 5 minutes. Serve hot. ●

Avial ***(Vegetables in Coconut and Curd – Kerala Style)***

Yield: 12 cups

Serves 10

Pressure Cooking Time 0 minute

2½ cups / 200 g	coconut grated
6	green chillies
2 tsp / 10 ml	cumin seeds
2 cups / 480 ml	water
1½ cups / 360 ml	sour curd (see page 83) beaten till smooth
400 g	yam cut into 4 cm long, 5 mm wide and 5 mm thick pieces
400 g	ash gourd de-seeded and cut into 4 cm long, 1.5 cm wide and 1.5 cm thick pieces
3 medium (350 g)	raw bananas cut into 4 cm long and 1 cm thick slices
3	drumsticks cut into 6 cm long pieces
250 g	red pumpkin cut into 4 cm long, 1 cm wide and 1 cm thick pieces

1 cup / 100 g

broad beans cut into 2.5 cm
long pieces

1 tbsp + 2 tsp / 25 ml

salt

¾ tsp / 3.8 ml

turmeric

2 sprigs

curry leaves

3 tbsp / 45 ml

coconut oil

1. Grind together coconut, chillies and cumin seeds into a paste, adding water (1 cup/240 ml) a little at a time. Add coconut paste to curd. Mix.
2. Pour remaining water (1 cup/240 ml) in cooker. Add remaining ingredients except coconut-curd mixture, curry leaves and oil. Stir.
3. Close cooker. Bring to full pressure on high heat. Remove cooker immediately from heat. Release pressure with slight lifting of vent weight. Open cooker.
4. Add coconut-curd mixture and curry leaves. Mix.
5. Place cooker with vegetables on high heat and bring to boil. Reduce heat to low and simmer about 2 minutes.
6. Put *avial* in a serving dish. Pour oil evenly over *avial*. Serve hot. ●

Adjustments for other than 5 Litre: For 8 Litre, 10 Litre and 12 Litre: do not increase quantity more than this 5 Litre recipe to avoid overcooking.

Chola Dal ***(Bengal Gram with Coconut)***

Yield: 6 cups

Serves 6

Pressure Cooking Time 9 minutes

2 tbsp / 30 ml	ghee
1/4 cup / 60 ml	coconut cut into 3 mm thick 5 mm squares
1/4 cup + 1 tbsp / 75 ml	mustard oil
2	whole dry red chillies
3	bay leaves
6	cloves
2 x 2.5 cm sticks	cinnamon
4	green cardamoms
1 tsp / 5 ml	cumin seeds
1 x 2.5 cm piece (10 g)	fresh ginger chopped
3	green chillies slit (see page 81)
2 tsp / 10 ml	jaggery shaved and packed
2 cups / 400 g	chana dal
1 tsp / 5 ml	turmeric
1 tbsp + 1/2 tsp / 17.5 ml	salt
3 1/4 cups / 780 ml	water

1. In a pan, heat 1 tbsp/15 ml ghee on medium heat about 1 minute. Add coconut pieces and fry till light brown. Remove coconut and ghee. Keep aside.

2. Heat oil in cooker on high heat about 2 minutes. Add red chillies, bay leaves, cloves, cinnamon, cardamoms and cumin seeds. Stir a few seconds. Reduce heat to medium. Add coconut with ghee and all other ingredients except water and remaining ghee (1 tbsp/15 ml). Stir fry about 2 minutes. Add water. Stir.

3. Close cooker. Bring to full pressure on high heat. Reduce heat and cook 9 minutes.

4. Remove cooker from heat. Allow to cool naturally.

5. Open cooker. In a pan, warm remaining ghee (1 tbsp/15 ml) on medium heat and pour evenly over *dal*. Serve hot. ●

Adjustments for other than 5 Litre: Adjust all ingredients proportionately except –

1. For 1.5 Litre and 2 Litre: reduce water by only 50%.
2. For 3 Litre and 3.5 Litre: reduce water by only 25%.
3. For 4 Litre: do not reduce water at all.
4. For 1.5 Litre, 2 Litre, 3 Litre and 3.5 Litre: change pressure cooking time to 12 minutes.

Illish Sarse Bata ***(Hilsa Fish in Mustard)***

Yield: about 6 slices + $\frac{3}{4}$ cup of gravy

Serves 3

Pressure Cooking Time 2 minutes

750 g **Hilsa fish** descaled, head and tail removed, body cut as shown below into 1.5 cm thick slices (about 6 slices)

1½ tsp / 7.5 ml

salt

$\frac{3}{4}$ tsp / 3.8 ml

turmeric

2 tbsp / 30 ml

mustard seeds

3

green chillies 1 whole, 2 slit (see page 81)

$\frac{1}{2}$ cup + 2 tbsp / 150 ml

water

2 tsp / 10 ml

curd

$\frac{1}{4}$ cup / 60 ml

mustard oil

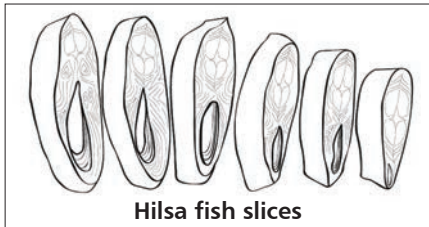

Hilsa fish slices

1. In a bowl, rub fish with salt and turmeric.
2. Grind together mustard seeds and whole chilli into a paste, adding water (2 tbsp/30 ml) a little at a time. Mix ground paste and curd. Rub paste-curd mixture on fish.
3. Heat 3 tbsp/45 ml oil in cooker on medium heat about 3 minutes. Add fish with paste-curd mixture, slit chillies, remaining water ($\frac{1}{2}$ cup/120 ml) and oil (1 tbsp/15 ml).
4. Close cooker. Bring to full pressure on high heat. Reduce heat and cook 2 minutes.
5. Remove cooker from heat. Release pressure with slight lifting of vent weight.
6. Open cooker. Serve hot. ●

Adjustments for other than 5 Litre: Decide the number of fish slices which will fit in one layer on the base of your cooker and then adjust the remaining ingredients proportionately except –

1. For 1.5 Litre, 2 Litre and 3 Litre: in Step 3, add $\frac{1}{4}$ cup/60 ml water instead of $\frac{1}{2}$ cup/120 ml.
2. For 3.5 Litre and 4 Litre: the full 5 Litre recipe can be cooked.
3. For 8 Litre, 10 Litre and 12 Litre: reduce pressure cooking time to 0 minute.

Khichuri (Soft Rice with Split Skinned Green Gram and Vegetables)

Yield: 12 cups

Serves 8

Pressure Cooking Time 4 minutes

1 x 5 cm piece (20 g)	fresh ginger
10 cloves	garlic
6	green cardamoms seeds taken out and kept, pods discarded
2 x 2.5 cm sticks	cinnamon
4	cloves
8 cups + 1 tsp / 1.9 litres	water
1 cup / 200 g	moong dal not washed
1/2 cup / 120 ml	mustard oil
4	bay leaves
2 tsp / 10 ml	cumin seeds
1 large (150 g)	onion chopped
1 cup / 200 g	Basmati rice washed and drained
1 small head (300 g)	cauliflower cut into flowerettes of about 2.5 cm
2 medium (200 g)	potatoes cut into 4 cm long, 4 cm wide and 2 cm thick pieces (see page 79)

1 cup / 150 g	peas shelled or frozen
1/2 tsp / 2.5 ml	turmeric
2 tbsp / 30 ml	coriander powder
1 1/2 tsp / 7.5 ml	red chilli powder
2 tsp / 10 ml	sugar
1 tbsp + 1 tsp / 20 ml	salt
2 tbsp / 30 ml	ghee

1. Grind together ginger and garlic into a paste.
2. Separately grind together cardamom seeds, cinnamon and cloves into a paste adding water (1 tsp/5 ml) a little at a time.
3. In a pan, stir *moong dal* continuously on medium heat till *dal* turns golden brown (about 7 minutes). Remove from heat, spread *dal* on a plate and allow to cool. Wash and drain *dal*.
4. Heat oil in cooker on high heat about 3 minutes. Add bay leaves and cumin seeds. Stir a few seconds. Add onion and stir fry till golden brown (see page 80, **Frying onions**). Add ginger-garlic paste. Stir a few seconds. Add *dal*, rice and all other ingredients except water, ground spices and ghee. Mix. Add remaining water (8 cups/1.9 litres). Stir.
5. Close cooker. Bring to full pressure on high heat. Reduce heat and cook 4 minutes.
6. Remove cooker from heat. Allow to cool naturally.
7. Open cooker. Add ground spices. Mix. In a pan, warm ghee on medium heat and pour evenly over *khichuri*. Serve hot. ●

Aloor Dum **(Spicy Potatoes – Bengal Style)**

Yield: 9 cups

Serves 8

	Pressure Cooking Time 1 minute
1 medium (100 g)	onion
1 x 1.5 cm piece (5 g)	fresh ginger
4	cloves
3 x 2.5 cm sticks	cinnamon
2 cups / 480 ml	water
1.5 kg, very small (3 to 4 cm diameter)	potatoes unpeeled
1 ³ / ₄ tsp / 8.8 ml	turmeric
2 cups / 480 ml	mustard oil
2	bay leaves
1 tsp / 5 ml	cumin seeds
1 medium (100 g)	onion chopped
1 large (150 g)	tomato chopped
1 ¹ / ₂ tsp / 7.5 ml	red chilli powder
2 ¹ / ₂ tsp / 12.5 ml	cumin powder
1 ¹ / ₂ tsp / 7.5 ml	coriander powder

1 tbsp / 15 ml	salt
1 tsp / 5 ml	sugar
2 tbsp / 30 ml	ghee

1. Grind together onion and ginger into a paste.
2. Separately grind together cloves and cinnamon into a powder.
3. Pour 1 cup/240 ml water in cooker. Add potatoes.
4. Close cooker. Bring to full pressure on high heat. Reduce heat and cook 1 minute.
5. Remove cooker from heat. Release pressure with slight lifting of vent weight.
6. Open cooker. Remove potatoes. Peel. Sprinkle ³/₄ tsp/3.8 ml turmeric on potatoes. Mix.
7. Group potatoes into 3 batches. Heat oil in a deep-fry pan on high heat about 5 minutes. Fry each batch till light brown and remove. Allow pan to cool about 5 minutes. Remove ¹/₄ cup/60 ml oil with a ladle. Strain. Put the strained oil in a large pan.
8. Place pan with oil on high heat. Heat about 2 minutes. Add bay leaves and cumin seeds. Stir a few seconds. Add chopped onion and stir fry till golden brown (see page 80, **Frying onions**). Add ground paste. Stir fry about 2 minutes.

Aloor Dum**(Spicy Potatoes – Bengal Style)** *continued*

9. Add tomato, chilli, cumin and coriander powders, salt, sugar and remaining turmeric (1 tsp/5 ml). Cook on high heat till oil shows separately (about 3 minutes), stirring occasionally.

10. Add potatoes. Stir carefully to coat potatoes evenly with *masala*. Add powdered spices and remaining water (1 cup/240 ml). Stir. Reduce heat to low and simmer about 5 minutes, stirring once.

11. Remove pan from heat. Pour ghee evenly over potatoes. Serve hot. ●

Adjustments for other than 5 Litre: Adjust all ingredients proportionately except –

1. In Step 3, do not reduce water (1 cup/240 ml) at all when cooking reduced quantities.
2. For 8 Litre, 10 Litre and 12 Litre: do not increase quantity more than this 5 Litre recipe to avoid overcooking.

Rasogolla

(Chhena Balls in Sugar Syrup)

Yield 10 *rasogolla*

Serves 5

Pressure Cooking Time 7 minutes

4 cups / 960 ml

whole milk

1 tbsp + 1 tsp / 20 ml

lemon juice

1 tsp / 5 ml

maida

1½ cups / 300 g

sugar

3 cups / 720 ml

water

1/8 tsp / 0.6 ml

rose essence**1. To make chhena:**

- a. Place a strainer over a bowl large enough to hold the milk. Line strainer with a muslin cloth large enough to hold the curds and then be tied by winding one corner around the others into a knot. Keep aside.
- b. Pour milk into a pan and bring to boil on high heat, stirring occasionally to prevent skin from forming on top. Reduce heat to medium. Add lemon juice. Stir till milk curdles (curds separate from whey). Cook till whey has a yellow tint and has turned from cloudy to clearer (about 2 minutes), stirring and scraping the sides and base of pan. Remove pan from heat.

6. Open cooker. Remove *rasogolla* carefully with a perforated ladle (*jhara*) and place in a serving bowl. Add essence to syrup in cooker. Mix. Using a ladle, put syrup in serving bowl around the *rasogolla*. Gently pour syrup with a spoon over tops of *rasogolla*. Serve hot or allow to cool before serving. If serving cold, skim off congealed fat before serving. ●

Adjustments for other than 5 Litre: Adjust all ingredients proportionately except –

1. For 1.5 Litre: a 50% quantity of this 5 Litre recipe can be cooked.
2. For 2 Litre and 3 Litre: a 70% quantity of this 5 Litre recipe can be cooked.
3. For 3.5 Litre and 4 Litre: the full 5 Litre recipe can be cooked.

- c.** Stir curdled milk and pour into muslin-lined strainer over the bowl (kept aside in step 1a). Strain till whey is drained into bowl.
- d.** Gather up corners of muslin and tie a knot above curds to make a bag. Place bag on a *thali*, plate or board with knot on top. Place a 2 kg weight (heavy object such as saucepan filled with water) on top of bag. Tilt *thali* slightly to drain and leave 20 minutes. Remove weight. Untie bag and remove *chhena*.
- 2.** Place *chhena* on a flat working surface/*thali* and knead with the heel of the hand about 30 seconds. Add *maida* and continue kneading till the *chhena* grains disappear and *chhena* becomes soft and creamy (about 6 minutes). Gather *chhena* into a ball (If *chhena* cannot be formed into a ball, knead *chhena* till a ball can be formed). Divide *chhena* ball into 10 equal portions. Form each portion into a ball about 3 cm in diameter. Roll each ball with slight pressure between palms till smooth and even.
- 3.** Put sugar and water in cooker. Place cooker on high heat. Bring to a boil, stirring continuously till sugar is dissolved. Reduce heat to low. Carefully place *chhena* balls one by one in the sugar syrup in cooker.
- 4.** Close cooker. Bring to full pressure on high heat. Reduce heat and cook 7 minutes.
- 5.** Remove cooker from heat. Allow to cool naturally.

Mixed Vegetable Pulao

Yield 13 cups

Serves 8

Pressure Cooking Time 3 minutes

1/4 cup + 3 tbsp / 105 ml	vegetable oil
1 tsp / 5 ml	cumin seeds
2	bay leaves
2 x 2.5 cm sticks	cinnamon
4	brown cardamoms
5	cloves
3 medium (250 g)	carrots cut into strips 2.5 cm long, about 5 mm wide and 5 to 7 mm thick
3/4 cup / 90 g	green beans cut diagonally into 2.5 cm long pieces
1 cup / 150 g	peas shelled or frozen
3 cups / 600 g	Basmati rice washed and drained
1 tbsp + 1 tsp / 20 ml	salt
3 1/2 cups / 840 ml	water

1. Heat oil in cooker on high heat about 2 minutes. Add cumin seeds, bay leaves, cinnamon, cardamoms and cloves. Stir a few seconds. Add carrots, beans and peas. Stir fry about 2 minutes. Add rice. Fry till rice turns opaque (about 3 minutes). Add salt and water. Stir.

2. Close cooker. Bring to full pressure on high heat. Reduce heat and cook 3 minutes.

3. Remove cooker from heat. Allow to cool naturally 5 minutes. Release pressure with slight lifting of vent weight.

4. Open cooker. Serve hot. ●

Tuvar Dal ***(Split Skinned Red Gram – Gujarat Style)***

Yield 9 cups
Serves 8

Pressure Cooking Time 3 minutes

7 cups / 1.7 litres	water
1½ cups / 300 g	oily tuvar dal
1 tsp / 5 ml	turmeric
1 tbsp + 2½ tsp / 27.5 ml	salt
1½ tsp / 7.5 ml	red chilli powder
1½ tbsp / 22.5 ml	coriander powder
⅓ cup / 65 g	jaggery shaved and packed
1 medium (100 g)	tomato chopped
3	green chillies slit (see page 81)
7 pieces	kokum
2 tbsp / 30 ml	coriander leaves chopped, lightly pressed into tbsp

Tempering

2 tbsp / 30 ml	vegetable oil
1 tsp / 5 ml	mustard seeds
½ tsp / 2.5 ml	cumin seeds

1	whole dry red chilli
1 sprig	curry leaves
a large pinch	asafoetida

1. Pour 4 cups/960 ml water in cooker. Add *dal*, turmeric and salt. Stir.
2. Close cooker. Bring to full pressure on high heat. Reduce heat and cook 3 minutes.
3. Remove cooker from heat. Allow to cool naturally.
4. Open cooker. Mash *dal* completely with back of a ladle to blend with liquid.
5. Place cooker with *dal* on high heat. Add remaining water (3 cups/720 ml) and all other ingredients except those for Tempering. Bring to boil. Reduce heat and cook about 5 minutes, stirring occasionally.
6. **Tempering:** In a pan, heat oil on medium heat about 1 minute. Add mustard seeds. When crackling, add cumin seeds, red chilli, curry leaves and asafoetida. Stir a few seconds and pour over *dal*. Stir. Serve hot. ●

Adjustments for other than 5 Litre: Adjust all ingredients proportionately except –

1. For 1.5 Litre: reduce ingredients by 80% and increase pressure cooking time to 5 minutes.
2. For 2 Litre: increase pressure cooking time to 4 minutes.

Vatanyachi Usal (White Pea Curry)

Yield 12 cups

Serves 10

Pressure Cooking Time 12 minutes

 $\frac{1}{2}$ cup + 2 tbsp / 150 ml

2 medium (200 g)

1 x 2.5 cm piece (10 g)

5 cloves

 $\frac{3}{4}$ cup / 60 g

2 tbsp / 30 ml

 $1\frac{1}{2}$ tsp / 7.5 ml $1\frac{1}{2}$ tsp / 7.5 ml $4\frac{3}{4}$ cups / 1.1 litres

2 medium (200 g)

2 medium (200 g)

1 tbsp / 15 ml

1 tbsp + 1 tsp / 20 ml

 $2\frac{1}{2}$ cups / 500 g**vegetable oil****onions** thinly sliced**fresh ginger** chopped**garlic****coconut** grated**coriander leaves** chopped,
lightly pressed into tbsp**red chilli powder*****garam masala* powder**
(see page 80)**water****onions** chopped**tomatoes** chopped**sugar****salt*****sukhe safed matar*** soaked
overnight or in hot water for
2 hours and drained

1. In a pan, heat 2 tbsp/30 ml oil on high heat about 1 minute. Add sliced onions, ginger and garlic. Fry till onions are transparent. Reduce heat to medium. Add coconut and fry till coconut is light brown. Remove from heat. Allow to cool. Grind together fried ingredients with coriander leaves, chilli and *garam masala* powders into a paste, adding water ($\frac{1}{2}$ cup/120 ml) a little at a time.

2. Heat remaining oil ($\frac{1}{2}$ cup/120 ml) in cooker on high heat about 3 minutes. Add chopped onions and stir fry till light golden brown (see page 80, **Frying onions**). Add ground paste. Stir a few seconds. Add tomatoes, sugar, salt and $\frac{1}{4}$ cup/60 ml water. Cook on high heat till tomatoes are pulpy and oil shows separately (about 5 minutes), stirring occasionally.

3. Add *matar*. Mix. Add remaining water (4 cups/960 ml). Stir.

4. Close cooker. Bring to full pressure on high heat. Reduce heat and cook 12 minutes.

5. Remove cooker from heat. Allow to cool naturally.

6. Open cooker. Serve hot. ●

Murghi ma Kaju ***(Chicken with Cashew Nuts – Parsi Style)***

Yield 9½ cups

Serves 8

Pressure Cooking Time 5 minutes

1 x 2.5 cm piece (10 g)	fresh ginger
15 cloves	garlic
1.5 kg	chicken pieces (legs cut into thighs and drumsticks; breasts cut in half lengthwise, each half cut crosswise into three pieces about 5 cm wide)
5	whole dry Kashmiri red chillies (see page 83) soaked in ½ cup / 120 ml hot water for 15 minutes, water drained and reserved
1 tsp / 5 ml	cumin seeds
½ cup / 80 g	cashew nuts broken into pieces
1½ cups / 360 ml	water
½ cup / 120 ml	vegetable oil
2 medium (200 g)	onions sliced
1 tbsp + 1 tsp / 20 ml	salt
3 tbsp / 45 ml	tomato ketchup
1 tsp / 5 ml	sugar

1. Grind together ginger and garlic into a paste.
2. In a bowl, rub ginger-garlic paste all over chicken pieces. Cover and keep aside 1 hour.
3. Grind together chillies and cumin seeds into a paste, adding reserved water in which the chillies were soaked (½ cup/120 ml) a little at a time.
4. Separately grind cashew nuts into a paste, adding water (½ cup/120 ml) a little at a time.
5. Heat oil in cooker on high heat about 3 minutes. Add onions and stir fry till golden brown (see page 80, **Frying onions**). Add chilli paste. Stir fry about 3 minutes. Add chicken. Cook on high heat about 10 minutes, stirring continuously. Add salt and remaining water (1 cup/240 ml). Mix.
6. Close cooker. Bring to full pressure on high heat. Reduce heat and cook 5 minutes.
7. Remove cooker from heat. Allow to cool naturally.
8. Open cooker. Add cashew nut paste, tomato ketchup and sugar. Return cooker to high heat. Cook till gravy thickens (about 2 minutes), stirring continuously. Serve hot. ●

Adjustments for other than 5 Litre: Adjust all ingredients proportionately except – for 1.5 Litre and 2 Litre: reduce water by 50%.

Lapsi **(Sweetened Cracked Wheat)**

Yield 9 cups

Serves 8

Pressure Cooking Time 1 minute

$\frac{3}{4}$ cup / 165 g	ghee
6 x 2.5 cm sticks	cinnamon
2½ cups / 500 g	daliya
4½ cups / 1.1 litres	water
2¾ cups / 550 g	sugar
6	green cardamoms seeds taken out and powdered, pods discarded
15	almonds blanched, skins removed and sliced
20	pistachio nuts sliced

1. Heat ghee in cooker on high heat about 3 minutes. Add cinnamon. Stir a few seconds. Add *daliya*. Reduce heat to medium. Fry till light brown (about 5 minutes), stirring continuously. Add water. Stir.

2. Close cooker. Bring to full pressure on high heat. Reduce heat and cook 1 minute.

3. Remove cooker from heat. Allow to cool naturally.

4. Open cooker. Add sugar. Stir.

5. Place cooker with *daliya* on medium heat. Cook till sugar is dissolved and ghee shows separately (about 10 minutes), stirring occasionally.

6. Add cardamom powder. Mix. Serve hot, garnished with almonds and pistachio nuts. ●

Glossary (Meanings and Methods)

Beat: To mix with an instrument such as a spoon, whisk or electric beater using a regular, rapid, rhythmic movement.

Blanch: To plunge food in boiling water. To blanch almonds: Pour boiling water over nuts, cover and allow to cool. Slip off skins. To blanch and peel tomatoes: Immerse tomatoes in rapidly boiling water for 1 to 2 minutes and remove. Allow to cool. Remove core and skin.

Blend: To combine two or more ingredients till they mix thoroughly.

Coconut milk: Select a coconut without cracks or mold on the shell. Shake coconut; you should be able to hear liquid inside; stale coconuts contain little or no liquid.

To make coconut milk: Break open coconut by holding the coconut in one hand against a hard surface and hitting the coconut with the blunt side of a heavy cleaver all around its 'equator'. At the first sign of a crack, hold the coconut over a bowl to collect coconut water. Though not coconut milk, it makes a refreshing drink. Taste a piece of coconut to check if it is rancid. Break the halves into smaller pieces. Slip a knife between coconut meat and the shell and pry loose the meat. It is customary to remove the brown skin from the meat, which is done with a potato peeler or paring knife. In the Hawkins Test Kitchen we have compared coconut milk made from coconut with and without the brown skin and found there is no difference in taste but the milk made with the brown skin is slightly

less white. Coarsely grate the coconut or cut the coconut meat into pieces of about 1.5 cm.

To extract good coconut milk always use the precise quantity of fresh coconut and water stated in the particular recipe. It is advisable to use hot water. Put coconut and the required water in a blender and mix the mixture until finely ground (about 5 minutes). Place muslin or a double thickness of cheesecloth over a bowl. Put mixture into cloth. After cooling, gather up the corners and squeeze through as much milk as possible. Measure the required milk and keep aside. The milk extracted first is called **thick coconut milk**.

To make **thin coconut milk**: Put the same coconut and the specified quantity of water in a blender. Repeat the same process of blending and extracting. Extra coconut can be grated and frozen.

Cutting potatoes: Cut the potatoes approximately, taking care not to exceed the stated dimensions. Potatoes are curved and in different shapes – the curves and shapes may be left as they are. What is meant by 'thick', 'wide' and 'long' is illustrated alongside.

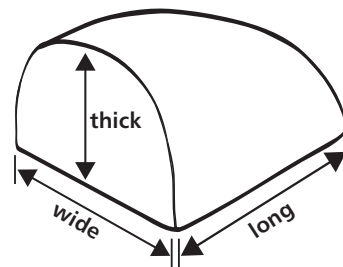

Frying onions: Correctly fried onions – uniformly fried to the desired colour – are important to the taste and texture of many recipes. Some recipes in this Manual require the onions to be fried until they are a colour described as "golden brown" and some recipes require the onions to be fried to a colour described as "light golden brown", as explained below. The recipes state to fry onions initially on high heat. After the liquid from the onions dries up, reduce heat when there is sticking. As the onions near the desired colour, the colour can change fast.

"Golden brown" means that the colour of the onions should be uniformly brown with a yellowish tinge rather than a flat, dull brown but NOT dark brown or black. Frying onions to "golden brown" requires time and attention so that the onions are fried evenly and just to the right colour. For example, it takes about 10 minutes to fry the 300 g grated onions in the **Rajma** recipe (page 61) to "golden brown" in a 5 Litre Hawkins.

"Light golden brown" means that the colour of the onions should be light brown with a yellowish tinge. This shade comes before "golden brown" is reached. For example, if it takes about 10 minutes to fry the 300 g grated onions in the **Rajma** recipe (page 61) to "golden brown" in a 5 Litre Hawkins, then "light golden brown" would be about 8 minutes.

Garam Masala powder:

Yield: About 2½ tbsp / 37.5 ml

1 tsp / 5 ml **peppercorns**

¾ tsp / 3.8 ml

cloves

7 x 2.5 cm sticks

cinnamon

4

brown cardamoms

seeds taken out and kept, pods discarded. Measure ¾ tsp / 3.8 ml seeds.

¾ tsp / 3.8 ml

black cumin seeds

(shah jeera) or cumin seeds

1. Roast together all ingredients in a small, heavy skillet (pan) on medium heat. Stir continuously until the spices darken by a few shades and give out their distinct aromas (about 5 minutes). Remove from heat, spread on a plate and allow to cool.

2. Grind to a powder. Store in an air-tight jar. May be frozen.

Garlic, clove of: One of the curved segments which make up one whole garlic bulb. A clove of garlic, from 1.0 to 1.5 g, which may be 2 to 3 cm long and about 1 cm at the widest part. If you have larger cloves, adjust the quantity appropriately.

Ghee: Clarified butter.

Ginger, fresh (Adrak): Peel off the smooth brown skin before grating or chopping. The recipes give the weight as well as the length of fresh ginger required. Since the width and thickness of ginger pieces vary, the width of a piece of ginger is taken to be 2.5 cm for quantities specified in the recipes. A 2.5 cm long and 2.5 cm wide piece of ginger is taken to weigh 10 g.

Grate (*Kasna*): To reduce food to fine particles by rubbing it against the surface of a grater (an abrasive implement with sharp-edged, raised perforations).

Green chillies: To slit a green chilli:

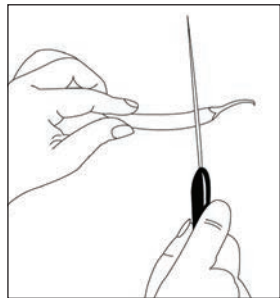

1. Cut off stem.

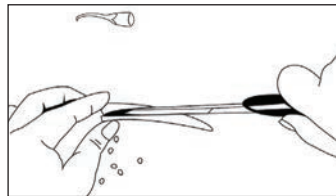

2. Cut through chilli from stem end to about three-fourths the length of chilli.

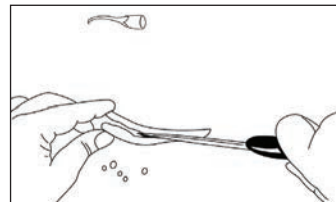

Grind: To crush into bits or fine particles by rubbing between two hard surfaces. The traditional way to grind fresh herbs, dry spices, pulses, coconut etc. is to use grinding stones (a hollow or flat stone slab and a stone roller called *sil batta*) or mortar and pestle. The modern and easier method is to use any of the various electric mixers, blenders or grinders.

Dry spices may be ground to a powder in a mortar and pestle, an electric coffee grinder or other spice grinder and a mixer-grinder. Place spices in grinder and operate machine until the spices are the required texture.

"Wet" ingredients such as chillies, garlic, ginger, coconut and onions – and whenever liquid is added – can be ground with a *sil batta*, in small electric choppers, mixer-grinders or food processors. For small quantities use the mixer's small grinding attachment. Cut food into small pieces or grate for easier grinding. When using an electric chopper, blend on high speed about a minute. Stop. Stir the ingredients preferably with a rubber spatula, scraping mixture from the sides of the jar. Continue electric mixing at high speed, stopping the machine and stirring occasionally until the mixture is the desired consistency. Adding liquid enables chopped items to become a smoother paste.

Some recipes require grinding both wet and dry ingredients into a paste. If you do not have a powerful machine for grinding, it may be easier to grind the dry ingredients separately (for instance, in a spice grinder) and add them to the wet ingredients while they are being ground (for instance, in a mixer-grinder). A little experimentation with your equipment will show the easiest way.

Jhara: A long-handled utensil with a round, slightly concave end with holes for draining of liquids.

Kokum: This fruit is often halved and sun-dried to a semi-dry stage before being sold in markets for use as a spice mainly in Maharashtrian, Konkani and Gujarati cuisine. When added to food

it imparts a pink to purple colour and a sweet and sour taste. It is a preferred substitute for tamarind in curries.

Maida (Refined flour): A white flour made from wheat which has had the bran and germ removed before grinding.

Mango powder (Amchur): Unripe mango which has been dried and then ground. It imparts a sour, fruity flavour. May be substituted with lemon juice.

Mava (Khoya): Milk which has been boiled down until all moisture has been removed. Available at dairy shops.

Muslin: A thin, plain-weaved cotton cloth.

Oily tuvar dal: It is regular *tuvar dal* coated with oil to increase its shelf life. The oil-coated variety is preferred by those who buy annual stocks of *tuvar dal* as the oil acts as a natural preservative. However, you should wash off the oil before use. Can be substituted with regular non-oily *tuvar dal*.

Paneer:

Yield: 400 g

10 cups / 2.4 litres **whole milk**

3 tbsp + 1 tsp / 50 ml **lemon juice**

1. Place a strainer over a bowl large enough to hold the milk. Line strainer with a muslin cloth large enough to hold the curds and then be tied by winding one corner around the others into a knot. Keep aside.

2. Pour milk into a pan and bring to boil on high heat, stirring occasionally to prevent skin from forming on top. Reduce heat to medium. Add lemon juice. Stir till milk curdles (curds separate from whey). Cook till whey has a yellow tint and has turned from cloudy to clearer (about 2 minutes), stirring and scraping the sides and base of pan. Remove pan from heat.

3. Stir curdled milk and pour into muslin-lined strainer over the bowl (kept aside in step 1). Strain till whey is drained into bowl.

4. Gather up corners of muslin and tie a knot above curds to make a bag. Place bag on a *thali*, plate or board with knot on top and press gently for a few seconds on knot to level curds. Tilt *thali* slightly to drain and leave 20 minutes. Untie bag and remove *paneer*.

5. Cut *paneer* as desired or as per recipe requirement. *Paneer* may be stored submerged in the whey for moister *paneer*. Whey may also be used to make soups, thin gravies and added to flour while kneading; or it may be discarded.

Puréed: Puréed food is a paste or thick liquid suspension made by grinding. Tomatoes may be puréed in a blender: remove cores first, blend till pulpy. Alternatively, rub tomatoes on a grater. Discard the hard skin and core, if any.

Red chilli powder: Whole dried red chillies which have been ground.

Roasting of spices: Before grinding, spices are sometimes roasted to bring out the characteristic aromas and to intensify their flavour. To roast, place spices in a small, heavy skillet (pan) on medium heat.

Stir continuously until the spices darken by a few shades and give out their distinct aromas. Remove from heat, spread on a plate and allow to cool. The term 'roast' is also used in some recipes in this Manual when the above mentioned procedure is to be followed except that **the spices are first added to oil, as noted in the recipes.**

Sieve: Utensil having a perforated or meshed bottom for separating solids or coarse material from liquid or fine particles.

Simmer: To cook gently just at or below the boiling point; adjust heat so that bubbles form, rise and break very slowly.

Sour curd: Curd which is more sour than normal. It generally takes at least a day after curd has set and been refrigerated to become sour enough for **Avial**. The hotter the weather while curd is being set, the faster curd sours. Curd progressively sours the longer it is kept. The degree of sourness is to an extent a matter of personal taste; adjust the storage time of the curd to suit the sourness preferred.

Thali: A round, flat, metal plate with a short straight rim; used for food preparation, serving or eating.

To extract tamarind pulp: Put tamarind in a stainless steel or glass bowl. Add hot water. Keep covered 30 minutes. Place a sieve over another stainless steel or glass bowl. Put soaked tamarind into sieve, reserving liquid. Push tamarind through sieve adding a little of the reserved liquid from time to time. Scrape pulp off sieve into the bowl. Using all reserved liquid, keep rubbing tamarind through sieve till all pulp has been extracted. Discard tamarind in sieve.

Whey: The watery part of milk that separates from the solid part or curd.

Whole dry Kashmiri red chillies: A type of chilli of mild to medium pungency used primarily to give red colour to food. The whole dry Kashmiri red chillies may be omitted in **Ma ki Dal** and **Rajma**. Substitute sweet paprika for colour in **Sambar**, **Kozhi Kootaan** and **Murghi ma Kaju**. ●

PARTS, DO-IT-YOURSELF REPAIRS AND SERVICE

Parts



There is available a full range of **genuine replacement parts** that may be required through the entire useful life of any Hawkins Pressure Cooker. Always use genuine Hawkins spare parts for your safety and the proper working and durability of the cooker.

Unscrupulous manufacturers and traders try to pass off fake parts which can badly affect the working and durability of your pressure cooker and may cause dangerous accidents. We have packaged the frequently used parts with a 'Hawkins Hologram'. To make sure that the pack is genuine, tilt pack – the Hologram must show the Hawkins label and Cooker alternately. Check the package before purchase.

Unscrupulous manufacturers have also copied our packaging. Your best guarantee of genuine Hawkins parts is to buy from reliable dealers you can trust. To help you identify such dealers, Hawkins has appointed Authorised Dealers and Hawkins Authorised Service Centres, each of whom has been issued a certificate from Hawkins Cookers Limited. To help you identify the part that you may require, enquire at these dealers, or visit hawkins.in/parts to find the part code required for your size and model of cooker. The size and model of your cooker are stamped on the base of your cooker. Replacement of some parts such as the gasket, safety valve and plastic handles can be done by consumers by following the instructions provided in this section. Other repairs must be done only by a Hawkins Authorised Service Centre or Hawkins representative. To help you locate a Service

Centre near you, the present **Directory of Hawkins Authorised Service Centres in India, Bhutan and Nepal** is available herein from page 89.

Commonly Required Parts

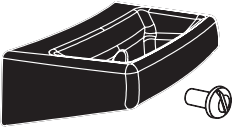
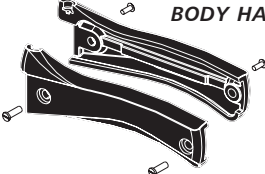
<p>GASKET/SEALING RING</p> 	<p>SAFETY VALVE</p> 
<p>VENT WEIGHT/ PRESSURE REGULATOR</p> 	<p>SUBSIDIARY HANDLE</p> 
<p>BODY HANDLE</p> 	<p>To find the Part Code for the required part which fits your specific pressure cooker, visit hawkins.in/parts</p>

Do-it-Yourself Repairs

Gasket Replacement

If leakage develops along the rim of the cooker body which is not due to the misalignment of the lid or a dent on the rim or lid curl, the gasket needs to be replaced. This is simply done by changing it with a replacement genuine Hawkins gasket to fit the size of your Hawkins (see **Getting to Know Your Hawkins**, page 9).

Safety Valve Replacement

1. Get a genuine Hawkins safety valve.



2. One or possibly two 19 mm³/₄ inch spanners (wrenches) are required to replace the safety valve – one for turning the nut on the top of the lid and, if required, one for holding the retainer on the underside of the lid.
3. One strong person can replace the safety valve as stated alongside.

TO REMOVE

1. Remove the gasket and vent weight from the lid.
2. Hold and brace the lid on a soft surface such as a folded cloth with the left hand. Take care not to bend or warp the lid curl. Do not hold the lid by the handle. With the right hand, place the spanner around the nut on the top of the lid under the handle bar (see **Picture 1**). Exert downward pressure counter-clockwise on the nut until valve loosens. If valve is too tight, soak lid in hot water for thirty minutes and wipe dry.

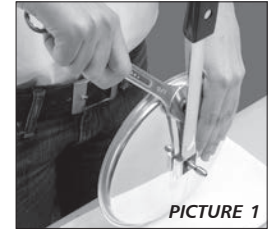

3. Grip lid as shown (see **Picture 2**). Hold retainer firmly in one place with the thumb of the left hand while grasping the lid with the same hand. (If required, cover the retainer with a cloth to protect thumb). With the right hand, place the spanner around the nut on top of the lid. Exert downward pressure on the nut (see **Picture 3**). Remove and re-apply spanner at a higher angle to the nut. Repeat procedure until

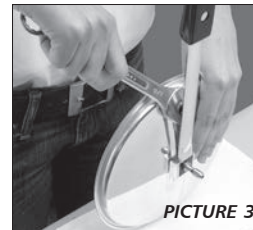

the nut can be unscrewed with fingers. Remove nut, retainer and washer. Discard all parts – do not reuse any part.

If you are unable to unscrew the safety valve, use a second spanner to hold the retainer and remove the safety valve as follows:

4. Place the ring end of one spanner on the retainer on the underside of the lid and hold it in place with the thumb of the left hand while grasping the lid with the same hand (see **Picture 4**).

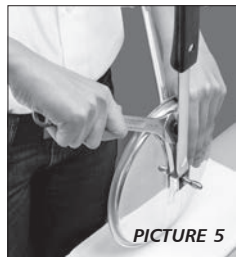

With the right hand, place the other spanner around the nut on the top of the lid (see **Picture 5**). Exert downward pressure on the nut. Remove and re-apply spanner on the nut at a higher angle. Repeat downward pressure. Repeat procedure until the nut can be unscrewed from the retainer with fingers. Remove nut, retainer and washer. Discard all parts – do not reuse any part.

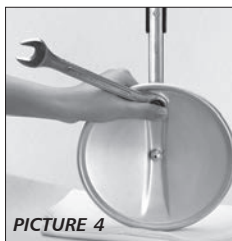

TO REPLACE

1. Clean all surfaces around the lid hole where the safety valve will sit and wipe dry.
2. Unscrew the new nut from the retainer (which is fitted with silicone washer) and keep them to one side.

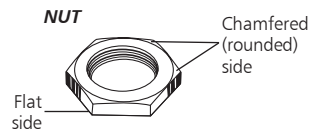
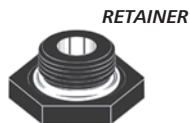

3. Push retainer with silicone washer into the safety valve hole from the underside of the lid and hold in place with the left hand.

Place the nut chamfered side down, flat side up around retainer threads on top surface of lid and screw nut in a clockwise direction with your fingers until tight (see **Picture 1**).



4. Hold the lid vertically and grip with your left hand. The top of the lid should be facing you. Hold retainer on underside of lid firmly in place with one or two fingers of left hand (If required, cover the retainer with a cloth to protect fingers). With the right hand, place the spanner around the nut on the top of the lid at an upward angle and exert downward pressure on the spanner

(see **Picture 2**). Repeat; tighten nut securely until it stops moving. Do not over-tighten – the threads may break.

If you are unable to tighten the nut, use a second spanner to hold the retainer and tighten the nut as follows:

5. Hold the lid handle in your right hand and turn the lid upside down, that is, with the underside of the lid facing you and the top side of the lid lying flat on the soft, folded cloth on a table. With the left hand, position the ring end of one spanner around the retainer on the underside of the lid and hold it in place with the fingers of the left hand while grasping the lid with the same hand (see **Picture 3**).

6. Raise the lid vertically holding the lid with your left hand with the ring spanner in place on the retainer (to stop its rotation when you tighten the nut). Now the underneath of the lid will be away from you and the top of the lid will be facing you.

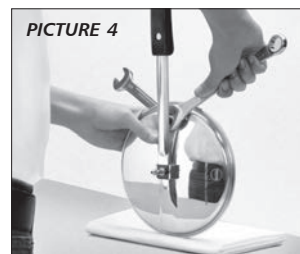
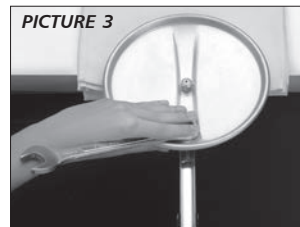

With the right hand, position the second spanner around the nut on top of the lid at an upward angle and exert downward pressure on the spanner (see **Picture 4**). Repeat; tighten nut securely by repeating the downward strokes of the spanner until the nut stops moving. Do not over-tighten – the threads may break.

Replacement of Plastic Handles

The subsidiary body handle and the body handle are replaceable by unscrewing the existing handle and screwing on the replacement handle with a screwdriver. For the body handle: place the two halves of plastic body handle on either side of the metal bracket. Join them together, insert studs and tighten the screws into studs from the opposite side.



If the subsidiary or the body handle is difficult to unscrew, a second person holding the cooker body firmly while one person turns the handle screws anti-clockwise will make it easier.

THE HAWKINS REPAIR KIT

The Hawkins Repair Kit is available to help you do some repairs yourself if your pressure cooker is one of those listed below. The repair kit contains one gasket, one safety valve, one subsidiary handle, one body handle, a spanner and instructions. The only additional tool you require is a screwdriver for replacing plastic handles.



The Repair Kit is designed for the following pressure cookers:

- Classic 3.5, 4, 5, 6.5 and 8 Litre Tall
- Hevibase 3.5, 5 and 6.5 Litre
- Contura and Contura Black 3.5, 5 and 6.5 Litre
- Ceramic-Coated Contura 5 Litre

Some general repairs using the Hawkins Repair Kit are given in the booklet accompanying it. ●

Service

Hawkins Authorised Free Service

Hawkins offers free service throughout the life of your pressure cooker at its wide network of Authorised Service Centres all across India, Bhutan & Nepal. These Authorised Service Centres will replace without any charge parts which are under guarantee. Normal replacement parts, namely safety valves, gaskets and plastic handles are not covered under this guarantee. Even beyond the guarantee period for the entire life of the cooker, Hawkins Authorised Service Centres are contracted to charge only for parts replaced and not for labour.

Each of these Service Centres has been trained at the factory training centre. Only such trainees that meet our standards are appointed as Service Centres.

These Service Centres are checked periodically by trained company personnel. Such evaluations form a basis for the remuneration of the Service Centres by Hawkins.

To help you identify such dealers, every Hawkins Authorised Service Centre has been issued a certificate from Hawkins Cookers Limited.

Directory of Hawkins Authorised Service Centres

This Directory contains the list of Hawkins Authorised Service Centres in India, Bhutan and Nepal as on April 1, 2022. The list is subject to change. Consumers are advised to verify that the service centre holds a valid certificate from Hawkins Cookers Limited on the date of their visit. The updated list of Service Centres is available at hawkins.in/service.

ANDAMAN & NICOBAR

PORT BLAIR Dayalco Q 9933272914

ANDHRA PRADESH

ELLURU Sree Vijaya Watch & Electronic Q 9948544444 **KURNOOL** Andhra Kitchenware Q 9849028881 **NELLORE** Sri Saibaba Home Appliances Q 9866367401 **RAJAHMUNDRY** Andhra Machines Agencies Q 9440789287 **TIRUPATI** Raunaq Enterprises Q 8008423221 **VIJAYAWADA** Srinivasa Metal Stores Q 9246632002 **VISAKHAPATNAM** Andhra Machines Agencies Q 9848812365

ARUNACHAL PRADESH

NAHARLAGUN Tana Steel House Q 9862536178

ASSAM

ABHAYAPURI Kamini Electricals Q 9954458358 **BARPETA ROAD** Nadiabashi Panchkori Saha Q 9435328340 **BARPETA TOWN** Dipali Stores Q 9435024950 **BIHUPURIA** Mazumdar Cycle Stores Q 8638396542 **BIJNI** Susama Steel House Q 7002915314 **BILASIPARA** Sethia Brothers and Co. Q 9435126562 **BISHWANATHCHARALI** Uday Shankar Stores Q 9435182747 **BOKAKHAT** Kamal Agencies Q 9435597314 **BONGAIGAON A.O.C. Road** Matri Bhandar Q 9435720812 • **M.G. Road** Alsons Q 7028548878 • **Main Road** Associated Agencies Q 9435022212 **DEMOW** Satabdi Q 9957020845 **DHUBRI** Roy Brothers

Q 9957088807 **DIBRUGARH** Gift Palace Q 9101161342 • Khub Chand & Sons Q 9101708620 **DIGBOI** Radio Mart Q 7002089949 **GOLAGHAT** G N Crockery Q 9954115796 **GUWAHATI Bamuni Maidan** Indigo Flame Q 9864085651 • **Fancy Bazar** R Champaklal (Assam) & Co Q (0361) 2541414 • Shyam Metal Stores Q 9435548648 • **Lakhtokia** C.M. Store Q 9864093399 • Mirror & Glass House Q 9706012454 • **Paltan Bazar** Ravi Prakash Anand & Co. Q 9954178795 • **Pandu** Suchitra Flame Q 8638980963 **HOJAI** Kamkhaya Stores Q 9435168217 **JAGI ROAD** S.N. Banerjee & Sons Q 9435064677 **JORHAT** Roy and Co. Q 9954029061 / 8761810997 **KARIMGANJ East Market** Sree Ma Glass House Q 9435076426 / 8011617456 • **Station Road** Stationery Stores Q 9678735727 **KOKRAJHAR** Lakshmi Narayan Stores Q 7002340119 **MANGALDAI** Monex Electrics Q 6001990427 **MORANHAT** Tiwari Toolies Center Q 9101172687 **NAHARKATIA** Dutta Brothers Q 8638418924 **NALBARI** Baruah Traders Q 9435027564 / 8638956518 • Maruti Associates Q 9864791171 **NORTH LAKHIMPUR N.T. Road** Dutta Brothers Q (03752) 796395 • **S.B. Road** Jiban Jyoti Q (03752) 244337 **NOWGONG Dacca Patty** New Sitanath Bhandar Q 9707334745 • **Marwari Patty** Kitchen Appliances Q 9435061128 **RANGIA** Krishna Bhandar Q 9917839840 **SARUPATHAR** Lahkar Agro & Electricals Q 9435196874 / 8761884821 **SIBSAGAR** Nivedan Q 9435277777 **SILCHAR Fatak Bazar** Prabhat Chandra Paul Q 9435175236 • **Jani Ganj Bazar** Rakesh Crockery Distributors Q (03842) 232081 **TEZPUR** Kitchen Centre Q 9435083364 **TINSUKIA G.N.B. Road** Geeta Enterprises Q 9435035725 • **Thana Road** Maruti Enterprises Q 9435035880

BIHAR

ARRAH Arihant Enterprises Q 9430929737 **AURANGABAD** Shree Kitchen King Q 7870276464 **BARAUNI** Sinha & Co. Q 7079822810 **BEGUSARAI** Rimjhim Stainless Steel House Q 9334640758 **BETTIAH** National Stores Q 9835211194 **BHAGALPUR** Santosh Stores Q 9431277444 **BIHARSHARIF** Jain & Brothers Q (06112) 232787 **CHAPRA** **Hathwa Market** Rastogi Glass House Q 9431408239 • **Kutchery Road** Shankar Stores & Corp. Q 9708307498 **DALSINGHSARAI** Lakshmi Narayan Lal Vijay Shankar Prasad Q 9835807557 **DARBHANGA** Shagun Q 9934680426 **DEHRI ON SONE** Glassina Q 7903435572 **GAYA** Fancy Steel Centre Q 8092445100 **GOPALGANJ** Cooker House Q 9430292174 **HAIJIPUR** Bhagirathi Steel Centre Q 9471916999 **JAYNAGAR** Mahavir Glass Company Q 9931594238 **JOGBANI** Deepak Stores Q 9546953401 **KATIHAR** **Mangal Bazar** Raju Steel Q 9431229183 • **New Market** Roop Rang Q 9431626481 **KHAGARIA** Gacil Q 9431210091 **KISHANGANJ** Prakash Stores Q 9431232215 **LAHERIASARAI** Welcome India Q 7004173198 **MADHUBANI** Lav Kush Q 7004195456 **MAIRWA** Gopalji Barnwal & Brothers Q 9431262284 **MOTIHARI** Mohan Stores Q 7257929180 / 7488025383 **MUNGER** Jalan Traders Q 9431237242 **MUZAFFARPUR** **Kalyani Chowk** Greehshobha Q 9430805123 • **Motijheel** Dada Glass & Gift 9835533633 / 9334279998 • **Saraiya Ganj** Bajrang Steel House Q 9431431870 / (0621) 2210576 **PATNA** **Kankarbagh** Patna Steel House Q 9430557627 • Raj Sales Q 7488073108 • **Muradpur** Steel Corner Q (0612) 2677336 • **New Market** Crockerico Q 9852192204 • Harilal Q 9835829658 • **West Boring Canal Road** Chandrawati Enterprises Q 9334766170 **PURNEA** **Bhatta Bazar** Das Enterprises Q 8051281151 • **Lakhan Chowk** Lakhan Lal & Co. Q 7547003000 **SAMASTIPUR** Maharaja Steel Q 6205558363 / 9931454837 **SASARAM** Ashoka Steel Q 9431028768 **SITAMARHI** Sri Ram Stores Q 9835267066

CHANDIGARH

Sec 15-D Indian Crockery House Q (0172) 5003273 / 8437145000
• **Sec 17-E** Jagatsingh and Sons Q (0172) 5078238 / 9872842162

• **Sec 26** Agarwal Distributors Q 9876022299 / (0172) 5077734 •
Sec 20-C Sethia Trading Company Q 9877723798

CHHATTISGARH

AMBIKAPUR Sahu Bartan Bhandar Q 9425256015 **BAIKUNTPUR** Shivhare Crockery Store Q 9425256750 **BHILAI** Gargi Gen Stores Q 9302727101 **BILASPUR** New Ramshyam Metal Stores Q 9425545711 **DURG** J.K. Kitchenware Q 9893942942 **KORBA** Mamta Steel Emporium Q 9826199483 **RAIGARH** Nihal Chand Govind Ram Patra Bhandar Q 7587288011 / 9907363616 **RAIPUR** M.S. Traders Q 9424243000

DELHI

Azad Market Balaji Glass & Crockery House Q (011) 49095952 / 9350095900 • **Badarpur** Salekh Chand Goel & Sons Q 9899708641
• **Burari** Shree Balaji Bartan Bhandar Q 9999881527 / 9899904965
• **Chandni Chowk** Bhagwan Das Jagannath Q (011) 23267554 / 9818271742 • Punjab Stainless Steel House Q (011) 43052875 / 9810110661 • **Delhi Cantt.** Aggarwal Bartan Wale Q 9999201238 • **Dwarka** Paradise Kitchenware Q 9971383842 • **Geeta Colony** Solanky Bartan Q 9818916763 • **Govind Puri** Kalka Steel Centre Q (011) 42420987 / 9810093625 • Om Steel Centre Q 7065657007 • **Kakrola More** Aarti Bartan Bhandar Q 8800716096 • **Karol Bagh** Jain Bartan Bhandar Q 9654475144 • Sargodha Bartan Store Q 9810400655 • **Kingsway Camp** A.A.A. Enterprises Q (011) 47192077 • **Kotla Mubarakpur** Bhagwan Dass & Company Q 9899445444 • Rajasthan Hardware Store Q 9811136744 • **Krishna Nagar** Shri Krishna Bartan Store Pvt Ltd Q 9810642851 • Shri Ram Bartan Store Q 9868289262 • **Lajpat Nagar** National Bartan Bhandar Q 9810033889 • **Laxmi Nagar** G.K. Traders Q 9210818163 • **Malviya Nagar** Verma Home Appliances Q 9818128812 • **Mehrauli** R.P. Goel Q 9958012599 • **Model Town** Bihari Bartan Bhandar Q 9871267272 / 9711224651 • **Nangloi** Gupta Bartan Bhandar Q 9871611500 • **Narela** R.G. Steel Q 9350169836 • **Palam** Micky Jain Store Q 9810407308 • **Palam Colony** Bhardwaj Bartan Bhandar

Q 9810136860 • **Paschim Vihar** Mahavir Crockery Q 9810348587 • **Patparganj** Bharat Bartan Bhandar Q (011) 22755762/ 9810188837 • **Rajouri Garden** New Variety Store Q 9810138686 • **Rani Bagh** Bharat Bartan Bhandar Q 9312237552 / 9711717217 • **Rohini** Jain Kitchen Gallery Q 9313216141 / 9811267455 • S.B.R. Enterprises Q 9958610150 / 9555365004 • **Sadar Bazar** Anil Marketing Q 9811813546 • Brij Kishore & Sons Q 9354373929 • Gandhi Steel Centre Q 9810296531 / 8860939821 • **Shahdara** Balaji Traders Q 9811219213 • Deepak Bartanwala Q 9312259531 • **Tikri Kalan** Shri Narsingh Enterprises Q 9560663569 • **Uttam Nagar** Shiv Light House Q 9212280515 • **Wazirpur** Goyal International Q (011) 49428580 / 9810029308

GOA

MARGAO Swastik Steel & Appliances Q 8793531385

GUJARAT

ADIPUR Shreeji Marketing Q 9879109811 **AHMEDABAD** Ellis Bridge Manglam Q 9979228842 • **Isanpur** Dhanlaxmi Vasani Bhandar Q 9725121860 • **Manek Chowk** Alankar Metal Corporation Q 9377110759 • **Sabarmati** Shreeji Vasani Bhandar Q 9904527765 • **Satellite** Suraj Sales Q 9426044876 • **Satellite Road** Madhuram Q 9879933502 **BARODA** **M.G. Road** Kansara Bapulan Ranchhodji Q 9998792952 • Virar Stores Q (0265) 2436745 / 9428761355 • **R. V. Desai Road** Vibgyor Marketing Q 9426035722 **BHARUCH** Ambica Vasani Bhandar Q 9427835569 **CHIKHLI** Nutan Sales Agency Q 9998814647 **DHORAJI** K. Sons Q 9428282007 **GODHRA** Vardhman Sales Q 9426387865 **JAMNAGAR** Paramanand Steel Centre Q 9824098197 **JUNAGADH** Mansukhlal Gokaldas Q 9824394697 **NADIAD** Prakash Metals Q 9408395053 **NAVSARI** Saifee Steel Q9824127546 **RAJKOT** Silver Steel Q 9427236787 **SURAT** Bhagal Abhishek Enterprise Q 9913870056 • **Sonifalia** Sha Thakordas Jivanram Q 9825543923 **VALSAD** Dayaram Vallabhram Kansara Q9979052369 / 9898267127 **VAPI** Jagdamba Enterprise Q 8733802255

HARYANA

AMBALA CANTT Kasera Bazar Budhram and Sons Q 9996497059 • **Saudagar Bazar** Jagat Singh & Sons Q9896075182 **AMBALA CITY** Sachdeva Bartan Bhandar Q 9812003793 **BALLABHGARH** Devi Charan Mukat Lal Q 9958750901 **BHIWANI** Shree Balaji Bartan Store Q 9992375379 **FARIDABAD NIT 1** Gurukripa Bartan Bhandar Q 9999858862 • **Sector 6** Gulati Distributors Q 9654409874 **GURGAON Chakkarpur** Palak Kitchenware Q 9818645853 • **Sadar Bazar** Classic Kitchenware Q 9810132875 • **Sector 52** Crockery Point Q 9649541757 • **Sona Chowk** Gogia Bartan Store Q 9811226789 • **South City 2** Sampurn Kitchenware Q 9818779549 **HISSAR** Kewal Krishan Inder Sain Q 9992225559 **JAGADHARI** Bharat Traders Q 9996059506 **KAITHAL** Banshiram Bhagwandas Q 9896038663 / 8529000003 **KALKA** Aggarwal Trading Co. Q 9996143364 **KARNAL** Kamal Cookwares Q 9416666493 **KURUKSHETRA** Kumar Bartan Store Q 9050328063 **PANCHKULA** Mitthu Gas Stove Corner Q 9041411663 / 9501881234 **PANIPAT** Mohar Singh Dari Mal Q 8950033427 **REWARI** R.B. Steels Q 9466356351 **ROHTAK** Prakash Crockery House Q 9215593100 **SIRSA** Bhagat Singh Chowk Agarwal Bartan Bhandar Q 9215220689 • **Rori Bazar** Nandlal Pawan Kumar Q9215220951 / 9416263753 **SONEPAT** Ashok Nagar Shridhar Bartan & Crockery Store Q 9215140050 • **Jamalपुरa** Prakash Bartan & Crockery House Q 9416189866

HIMACHAL PRADESH

BILASPUR Jiwan Ram Ved Paul Q 9816166935 **HAMIRPUR** Hind Traders Q 8006300036 **KANGRA Main Bazar** Gupta Sewing Machines Q 9816061079 • **Opp. Punjab National Bank** Shiv Shakti Traders Q 8585985401 **MANDI** Roop Chand Dalip Chand Q 7876093084 / (01905) 222263 **MAGHALA** Joginder Pal Rupesh Kumar Q 9805300000 **NAGROTABHAGWAN** Dharam Paul & Sons Q 9816045088 **PAPROLA** Braham Dass Yoginder Paul Q 9816695307 **ROHRU** United Traders Q 7807024444 **SHIMLA** Radha Mal Bishan Dass Q 9816612438

JAMMU & KASHMIR

AKHNOOR Dwarka Bartan Store q 9419100159 **ANANTNAG** Aaqib Enterprises q 9622431786 **JAMMU Patta Bohri Chungi** Anand Bartan Store q 9797399678 • **Raghunath Bazar** Ladhmal Desraj Jain q 9796477727 **KATHUA** Hari Om Bartan q (01922) 356043 **R.S. PURA** Ranbir Kingsway q 9796253357 **SRINAGAR** Amira Kadal Khan Traders q 9086858591 • **Lal Chowk** Cosmos House q 9419009163 • Super Agencies q 9622429518 • **Maharaja Bazaar** New Diamond Enterprises q 9419479419

JHARKHAND

BOKARO STEEL CITY Bombay Variety Stores q 9771117696 **CHAIBASA** K.C.P. and Sons q 9934373863 **DEOGHAR** Baidyanath Electric Stores q 9304629345 / 9431158545 **DHANBAD** Chulha Ghar q 9123189099 **DUMKA** B.K. Enterprises q 9470112900 **GIRIDIH** Prasad Glass Stores q 7858886336 **GODDA** Anuj General Store q 9939573010 **HAZARIBAGH** Crockery Emporium Q9431140727 **JAMSHEDPUR** New Kumar Fancy Stores q 9431300634 / (0657) 2321179 **JHUMRITELAIYA** Bharat Glass House Q9304229474 **KATRASHGARH** Shree Guru Shakti Trunk House q 9471119379 **RAMGARH CANTT** Swati Agencies q 9431146229 **RANCHI Main Road** Budhia's Collections q 8987462888 • **Namkum Road** Vinayak Vitrak q 9162621275 • **Ratu Road** New Gift Palace q 9470332738

KARNATAKA

BELGAUM Maruthi Galli Revankar Electricals q 9880575051 • **Shahapur** Hajare Kitchenware q 7090159888 **BENGALURU** Chandra Layout Pavan Kitchen World q (080) 41685852 / 49542973 • **Chickpet** Raja Trading Company q (080) 22871972 • **Rashmi Steels** q 9590625626 • **Indira Nagar** Pots and Pans International q (080) 40936530 / 9620365158 • **Jayanagar** Vishaal's q (080) 49928033 / 9916969289 • **Nagarathpet** Manish Enterprises q 8951853934 • **Rajajinagar** Mahalaksmi Metal House q (080) 23355994 / 9845356609 • **Sampangiramnagar** Sri Padmavathi Marketing q (080) 41162785 • **Vijayanagar** Mahendra's 92

q 9986102112 **COORG** Mahalaxmi Bhandara q 9448074226 **GULBARGA** Main Road Maharaja Steel Palace q 8884276519 • **Supermarket** Limkar Agencies q (084) 72228700 / 9481636270 **HUBLI** T K Baddi Griha Vaibhav q (083) 62363627 **KARWAR** Khadi Mulla q 8951077917 / 9448573148 **MANGALORE** Bharat Steel & Gift Centre q (0824) 2411349 **MYSORE** Mohan Bhandar q (0821) 2442190 **PUTTUR** Harsha q (08251) 238917 **UDUPI** Harsha q (0820) 2521841 / 2521842

KERALA

ALLEPPEY K.M.S. Vessels Merchant q 8136863988 **ALWAYE Catholic Centre** Wireless Metro q (0484) 2625186 • **Lourde Centre** C.C. Mathappan & Company q (0484) 2624551 / 8136848613 **ANGAMALY** Mundadans Kitchen World q 9526442479 **BADAGARA** Bright Marketing q 9846284680 **CALICUT** Bright Metals q (0495) 2721242 **CHANGANACHERRY** Al Shah Enterprises Pvt Ltd q (0481) 2420635 / 9447114333 **CHAVAKAD** New Kerala Gift House q 9544410003 **CHERUKUNNU** Gajanana Kitchenwares q 9447483421 **IRINJALAKUDA** J.J.Stores q 9447032526 **KALPETTA** Grihalakshmi Metals q 9447444804 **KANJIRAPALLY** Madiath Steels & Agencies q 9495980337 **KANNUR** Grihalakshmi q 9847011700 **KAYAMKULAM** Kwality Home Appliances & Sports q (0479) 2448685 **KOCHI** Broadway Anthony Francis & Son q (0484) 2352897 / 2367547 • **Jew Street** Cochin Steel House q (0484) 2351628 **KODUNGALLOORE** Pilla Metals q 9495635234 **KOLENCHERRY** Mini Steel House q 9447581207 **KOLLAM** V.V. Kitchen Ware q 9495007819 **KOLLENGODE** K.K.N. Metals q 9447084058 **KOTARAKARA** Jaya Steel House and Shopping Centre q (0474) 2452191 **KOTHAMANGALAM** Kottancheril Agencies q (0485) 2823920 **KOTTAYAM** Al Shah Enterprises Pvt. Ltd. q (0481) 2568635 • **Bhuvana Metal Mart** q (0481) 2561341 **KUNNAMKULAM** Kochu Stationery q 9846981513 **MALAPPURAM** New Noble Crockerries q 9744407265 **MANJERI** Korambayil Fancy and Fibres q 9946735277 **MATTANUR** K. Balan Nambiar & Sons q 9747666605 **MUVATTUPUZHA** Mini Stores q (0485) 2832408 / 9048000117 **NORTH PARUR** Mariya Marketing q 9656337023 **PALAI** Arackal Gift House q (0482) 2212618 **PALARIVATTAM** Shanthi Vessels q (0484) 2348898 **PALGHAT G.B. Road** Gift House q 9746989814 • **Opp. Head Post Office**

Yemkay Agencies q (0491) 2544028 **PATHANAMTHITTA** Alankar Hyper Market (0468) 2322217 **PAYYANOOR** K.V. Raman Metals q 9895545982 **PERINAD** Sakthi Agencies q (0474) 2702476 **PERUMBAVOOR** Pittappillil Agencies q (0484) 2590713 **SHERTALLAI** Panazan Enterprises Pvt Ltd q (0478) 2830500 **TALIPARAMBA** Shalimar Stores q 9895324395 **TELLICHERRY N.C.C. Road** Crockery Bazar q 9544322442 / 8089699110 • **Near Railway Flyover** Sreenivas Trading Corpn. q 9037551800 **THALAYOLAPARAMBU** Maria Agencies q 9446919781 **TIRUR** P.V. Balakrishnan Nair & Sons q 8129351515 **TRICHUR NH Bypass Road** Home Plus q 9048374725 • **Post Office Road** Kitchen World q (0487) 2424172 • Lal's Mega Sales Corp. (Steelalayam) q (0487) 2446306 **TRIPUNITHURA** Maria Steel House q (0484) 2781622 **TRIVANDRUM** S Ibrahim and Co. q (0471) 2460262 • S.R.T. Metal Mart q (0471) 2471349 **VENGARA** Steel House q 9562450836

MADHYA PRADESH

BALAGHAT Grah Shobha Steel Palace q 8989852500 **BHOPAL Kolar Road** Sona Kitchen Palace q 9301287747 • **New Market** Animesh Traders q 9893988120 • Golden Sales & Service Centre q 9425649702 • **Opp. Jumerati Post Office** S.N.R. Distributors q 9827243674 **CHHATARPUR** Rawat Stores q 9993036084 **CHINDWARA** Steel Home q 8989882510 **DABRA** Jain Fancy Bartan Bhandar q 9977959911 **DAMOH** Binny Stores q 9425436676 **GUNA** Sachin Steel Centre q 9179656262 **GWALIOR** Pahooram Pesuram Lokwani q 9179300677 **INDORE Kasera Bazar** Munimji Ki Dukan q 9300020594 • **Ram Laxman Bazar** N.R. Kitchenware Pvt. Ltd. q 9752341291 **JABALPUR Gorakhpur Market** Bombay Steel Center q 9340758568 • **Kotwali Bazar** Lakhnan Bartan Bhandhar q 9826563450 • **Marhatal** Mahalaxmi Traders q 7000302607 • **Near Miloniganj Telephone Exchange** Panda Metals q 9755790777 **KATNI** Cooker House q 9300005787 **KHANDWA** Khandwa Plastic Centre q 9425020501 **MANDSAUR** Snehdeep Agencies q 9425977504 **NAGDA** Ramchandra Premkumar Kasera q 9713678221 **RATLAM** Ramdayal Brothers q 9977299782 **REWA Kala Mandir Road** Gupta Sales Corporation q (0766) 2406621 / 9425824090 • **Venkat Road** Vijay Cooker Store q 9425186373 **SATNA** Giftto Steel Centre q (0767) 2234235

/ 9827519285 **UJJAIN** Mahalakshmi Patra Bhandar q 9893615530

MAHARASHTRA

AHMEDNAGAR Kashinath Trimbak Rasane q 9423791618 **AKLUJ** Motilal Ramchandra Velapure & Co. q 9923155561 **AKOLA** Mahalaxmi Metals q 8830958130 / 9420705969 **ALIBAGH** Shreepal Articles q 8007272670 **AMRAVATI** Rakesh Marketing q (0721) 2950077 / 9356760180 **AURANGABAD** S.A. Rasane & Sons q 9890037069 / 9421585989 **BARAMATI** Bhandari Steel Centre q 9822514646 **BARSHI** Yogesh Steel Emporium q 9623542550 **BEED** Shree Maher Steel q 9028874380 **CHIPLUN** Rajan Steel Bhandar q (023) 55260215 / 9422558433 **DEOLALI** Dharkar Metal Mart q 9823591458 **DHULE** Sakariya Enterprises q 9422786675 **GONDIA Bartan Bazar** Gopal Bartan Bhandar q (0718) 2238041 • **Main Road** Anjali Steel Centre q 9422130490 **ICHALKARANJI** Heramb Trade Group q (0230) 2434243 / 9404407854 **INDAPUR** R.D.Kasar q 8600814343 **KARAD** T. K. Mohire q 951181159 **KHAMGAON** Digambar Gopalrao Amle q 9096017703 / 9960603162 **KOLHAPUR Bhavani Mandap** Subhash Metals q (0231) 2542237 • **Mahadwar Road Corner** Vankudre Brothers & Co. q 9822318880 / 9881499298 **KUDAL** Samant Home Appliances q 9422054781 **LATUR** Ghar Sansar q 9422028526 **MUMBAI Andheri (West)** Satyam Home Appliances q 9867414251 • **Badlapur (East)** Mateshwari Steel & Home Appliances q 7028417279 / 9975010501 • **Borivali (West)** Oswal Steel Centre q 9819722051 / 8657401408 • **CBD Belapur** Om Steel & Home Appliances q 9702103994 • **Chembur** Milan Emporium q 9819890077 / (022) 25284408 • **Colaba** Just Kitchenware q (022) 22842569 • **Dadar (West)** B.C. Shah & Co. q 7710020676 / 9867626265 • **Goregaon (East)** Paras Novelty Centre q 9769233066 • **Kalwa** Kesaria Grah Vastu Bhandar q 9372043004 / 9892570985 • **Kalyan (West)** Maharashtra Gruh Vastu Bhandi Bhandar q 9975666714 • **Khar (West)** D.N. Jain q 9867241480 • **Lohar Chawl** Atlanta Enterprise q 9833284978 • **Mahim (West)** Hawkins Cookers Limited q (022) 24440807 • **Mulund (West)** Mehul Steel Centre q 7718067750 • **Panvel** Pooja Steel and Home Appliances q 9987232062 • **Sion (East)** Sri Murugan Steel House q 7710890470 • **Thane (West)** Vimal Steel q 9820115181 / 9870989908 • **Ulhasnagar (West)** Laxmi

Crockery Stores Q 7744822964 / 9822233114 • **Vasai (East)** Shri Devnarayan Sales & Service Q 9860899915 / 9511735411 • **Vashi** Milan Steel Q 9920621869 • **Vikhroli (East)** Mahee Enterprises Q 9967971999 • **Virar (West)** Atharva Home Appliances Q 9823496915 / 9860319220 **NAGPUR Gokul Peth** Dip Durga Home Appliances Q 9423634605 / 8793114411 • **Itwari** Rajesh Traders Q 9370935444 • **Mahal** Apsara Q 9960921116 • **Sitabuldi** M.S. Pande and Sons Q 9326080399 • **Teen Nal Chowk** Mahalaxmi Metal Mart Q 7798446655 **NANDED** Sandeep Distributors Q 9422173381 **NASIK Bhandi Bazar** P.R. Kale Distributors Q 9049811129 • **College Road** Deep Appliances Q 9922569954 • **Nasik Road** Mohan Metal Mart Q 9325570177 • **Panchvati** Chaudhary Sales, Services & Spares Q 7020038863 **PARBHANI Kranti Chowk** Pattewar Steel Emporium Q 9422877734 • **Shivaji Road** Sha Sonraj Anraj Q 9421388383 **PHALTAN** Krishna Bhandi Stores Q 8999423746 **PIMPRI Near Arya Samaj** Rajkumar Enterprises Q 9325155299 • **Pimple Saudagar** Kitchen World Q 7875754263 **PUNE Karve Road** Jain Metals Q (020) 25441708 / 9822887571 • **Kothrud** Tulsi Variety Q 9890773399 • **Narayan Peth** Laxmi Home Appliance Q 9422004487 • Sharada Stainless Steel Works Q 9890035818 • **Ravivar Peth** Pooja Stainless Q 9890182701 • **Tulsi Bagh** S.R. Purandare & Sons Q 9403353797 • **Vishrantwadi** Tanksale Marketing Q 9850993603 / 9890975643 **RATNAGIRI** Prakash Vastu Bhandar Q 9420055250 **SANGAMNER** Gruh Vastu Bhandar Q 9960373707 **SANGLI** Bhagate Steel Centre Q (0233) 2331539 **SATARA Palace Street** Aba Andoba Rangole Q 9146173174 • **Raviwar Peth** Mahalaxmi Metals Q9422606514 **SHIRUR** Kolapkar Super Market Q 9822008907 **SHRIRAMPUR** N.D. Dambir & Sons Q 9021867979 **SOLAPUR Chowpada** Rohit Steel Emporium Q 9370420146 • **Shukrawar Peth** Shashikant Jaykumar Mohare Q 9403771485 • Ujwal Jaykumar Mohare Q (0217) 2724711 / 9420702709 **UMBRAJ** Shankar Maruti Mohire Q 8767124133 **WARDHA** Mahesh Traders Q 9420061999 **YEOTMAL** Jai Gurudev Steel Q 9881486548

MANIPUR

IMPHAL Paona Bazar N Noyon Singh & Sons Q 9856979043 • **Thangal Bazar** Sudarshans Q 9862045003

MEGHALAYA

TURA Decora Q 9436112181

MIZORAM

AIZAWL Bada Bazar F.B. Stores Q 8974360567 • **Lower Zarkawt** Eastern Trading Agencies Q 9862426196 • **Tuikual "A"** Goodwill Agencies Q 9436150027

NAGALAND

DIMAPUR Church Road Potteries Emporium Q 0386 2225030 • **Circular Road** United Sales Corporation Q 9436002571

ODISHA

ANGUL Sunil Electric Supply Q 9938482097 **ASKA** Ashoka Enterprises Q 9338491716 **BAISINGA** Barsha Aluminium & Steel Q 9437103109 **BALANGIR** Shamuka Steel Centre Q 9437037810 / 9937531843 **BALASORE Cinema Bazar** Sri Ganpati Bartan Bhandar Q 9777276219 • **Hospital Road** Khandelwal Brothers Q (06782) 262715 • **Kacheri Road** United Sales Agency Q 9583519516 **BARGARH** New Patra Needs Q 9776922020 **BARIPADA** Aero Voice Q 9861828643 **BERHAMPUR Bhapur Bazar** Silagopalram & Sons Q 8249090616 • **One Way Traffic Road** Rajhans Distributors Q 9437027991 **BHADRAK Bont Chowk** Maha Laxmi Home Appliances Q 7381628318 • **Naya Bazar** New Suvadra Q 9439200000 **BHUBANESHWAR IRC Village** Pacific Traders Q (0674) 2360943 / 9338058849 • **BDA Colony** Baba Enterprises Q 7978856098 **CUTTACK** Pushpak Agency Q 9438016581 **JAGATSINGHPUR** Dash Agencies Q 9437318011 **JALESWAR Bada Bazar** Ashirbad Q 9040499001 • **Main Road** Sports 'N' Sports Q 8917637778 **JEYPORE** Una Enterprises Q 9437123611 **JHARSUGUDA** Jharsuguda Metal Store Q 9861277805 / 9437188425 **KENDRAPARA** Bijay Enterprises Q 7008816953 **KEONJHAR** Asha Ladies Corner Q 9437084556 **KORAPUT** Kar Electricals Q 7978820255 **PURI** Neeladri Shree Electronics Q 8327789718

RAIRANGPUR Friends Corner Q 986111373 **RAYAGADA** Bombay Steel House Q 8917281853 **ROURKELA Fertilizer Township** Sri Baldevjee Enterprises Q 9777342958 / 9437198917 • **Sector 5** Kitchen Accessories Q 7008058146 / 9437837833 **SALEPUR** Home Appliances Sales & Service Q 9438082077 **SAMBALPUR** Krishna Enterprises Q 9437552554 **TALCHER** Binod Trading Company Q 7008805650 **TITLAGARH** Mittal Enterprises Q 7978537451 / 7978474432

PUDUCHERRY

PUDUCHERRY Thiyagu Mudaliar Street Miracle Star Marketing Q 9786200990 • **Vellala Street** Prakash Wet Grinders Q 9443768361

PUNJAB

ABOHAR Chhabra Bartan Store Q 8872967776 **AMRITSAR** Gulzar Mal & Sons Q (0183) 2531685 • Raghbir Singh Kataria & Sons 9464229400 **BANGA** Javinder Kumar Shiv Kumar Q 9876060560 **BHATINDA Dobwali Road** Shree Ganesh Marketing Q 9872619301 • **Gandhi Market** Surinder & Co. Q 9417094614 / 9888487439 **DHURI Sadar Bazar** Ganesh Metal Store Q 7696567267 • **Totapuri Road** Shri Balaji Industries Q 9888825414 **DINANAGAR** Aggarwal Traders Q 9888227706 **GIDDARBAHA** Shiv Shankar Bartan Bhandar Q 9417647231 **GURDASPUR** Satish Kumar Ashwani Kumar Q 9814334891 **HOSHIARPUR** R.K. Bansal Traders Q 9463774885 **JALANDHAR Chowk Rainak Bazar** Gift Centre Q (0181) 5062200 • **Chowk Sudan** Bhagat Ram Hari Krishan Q 9888033231 • **Nakodar Road** Khazan & Company Q 8872235777 • **Naya Bazar** Dhawan Bartan Bhandar Q (0181) 2284282 / 9417089008 **KHANNA Amlah Road** Punjab Bartan Store Q 9888336606 • **Guru Amar Dass Market** R.S. Metals Q 9888690958 **LUDHIANA Chowk Ghumar Mandi** Chaudhry Crockery House Q 9872800407 • **Civil Lines** Jainsons Exclusive Q 9815396100 • **Lakkar Bazar** Rita Trading Company Q 9417271019 • **Meena Bazar** Nath Light House Q 9815337400 / 9915337400 **MALOUT** Gopal Singh Ramsingh Q 9872300724 **MOGA Bagh Gali** Goyal Plastic House Q 9814214878 / 9855514878 • **Main Bazar** Mange Ram Puran

Chand Q 9417194402 / 9463920946 **MOHALI** Aggarwal Crockery Q 9876022399 **NAWANSHAHR** Guru Nanak Bartan Store Q 9814209746 **PATHANKOT** Jagdish Raj Nanda & Sons Q 9463468405 • Maghar Mal & Sons Q 9888526154 **PATIALA** Munshi Ram Kaur Sain Jain Q 9815372480 **PHAGWARA** Matta Bartan Bhandar Q 9988226614 / 9814295228 **ROPAR** Amar Chand Pardeep Kumar Kapoor Q 9888677110 **SUNAM** Pawan Kumar & Sons Q 9915003483

RAJASTHAN

ABU ROAD Aggarwal Mohan Lal Suraj Mal Q 9413001502 **AJMER Kesar Ganj** Goyal Brothers Q 9509123456 • New M.L. Parakh & Sons Q 9799153715 • **Madar Gate** Natwar Vasan Bhandar Q 9982347880 **ALWAR** Ganga Sahai & Sons Q 9887140390 / 9828114410 **BANSWARA** Kansara Sambhulal Manaklal Q 9414725982 **BHARATPUR** Kishori Shyam Brijesh Kumar Q 9414975051 / 9414303600 **BHILWARA Sadar Bazar** Singhvi Vasan Bhandar Q 6376578796 • **Shastri Nagar** Vikas Industries Q 9829982985 **BIJAINAGAR** Shree Ganesh Metal Q 9414313621 **BIKANER** Kapoor Brothers Q 9829716333 **CHITTORGARH** Aap Ki Dukan Q 9414111385 **DAUSA** Dinesh Kumar Mahesh Chand Q 9414284116 / 9462610243 **DHOLPUR** B.L. Bartan Center Q 9309228578 **GANGAPUR CITY** Shri Badri Lal Kedar Lal Q 9413960396 / 9462690626 **HANUMANGARH** Gurunank Bartan Store Q 9024294318 **HINDAUN CITY** Babulal Mukesh Kumar Q 8952090511 / 7615035808 **JAIPUR Jhotwara** Kitchen King Steel & Gift Q 9784019601 / 9252336001 • **Mansarovar** Goel Enterprises Q 9829057444 / 9414303968 • **Nehru Bazar** Ashoka Departmental Store Q (0141) 4062710 / 9828577022 • **Raja Park** Long Life Departmental Store Q 9828568484 / 9828568483 **Sodala** Long Life Kitchenware Q (0141) 2220494 / 7737472113 • • **Tripolia Bazar** Mahaveer Stores Q 9462655567 **JODHPUR** Arora Marketing Q 8290695665 **KHETRI NAGAR** Amar Jyoti Fancy Stores Q 9460165691 / 9672826100 **KOTA** Shyam Agencies Q 9828303726 **PALI** Mandora Emporium Q 7597034050 / 9413261109 **SIKAR** Sikar Bartan Bhandar Q 9672866777 **SRIGANGANAGAR** Layalpur Bartan Bhandar Q 9829242483 **SUJANGARH** Sandeep Kumar Laxmi Kant Q 9529999344

SURATGARH Gill Watch & General Store q 9828700898 **TONK** Bhanwarlal Lallu Ram Katera q 9414334018 / 9461170112 **UDAIPUR** **Bapu Bazar** Shah Laxmilal Prakash Chandra Jain q 8766036621 / 9214539013 • **Suraj Pole** Lucky Stores q 6375216627 / 9351363270 • Swastik Metal Stores q 9414263544 • **Sector 4** Sapne Distributors q 9309363459

TAMIL NADU

ATTUR Abu Traders q 9842569408 **CHENNAI** **Adyar** New Annai Stores q (044) 24416522 • **Aminjikai** Amara Stores Pvt Ltd q (044) 26216181 • **Annanagar** Santhosh Super Stores q (044) 42955000 • **Saidapet** Ponmani Stores q 7947135659 • **Vadapalani** Supra CFA (Hawkins Depot) q (044) 23652244 / 9710445684 • **West Mambalam** Balaji Agencies q 9381029626 **CHIDAMBARAM** Sri Vinayaga Furniture & Stores q 9442737425 **COIMBATORE** **R.S. Puram** Ideal Stores q (042) 22557013 • **Raja Street** Chandran Steels q (042) 22397199 **DINDIGUL** **Dudley School** Sri Lakshmi Marketing q 7947108755 • **Main Road** New Jaikrishna Steel Mart q (0451) 2420120 **ERODE** Universal Traders q 8190024662 **HOSUR** Arul Stores q 9894362777 **KARUR** Ravi Eversilver Mart q (043) 24260453 **KOVILPATTI** Rajam Stores q (046) 32223901 **MADURAI** Ajantha Maligai q (045) 22620466 • S Chelliah Nadar and Sons q (045) 22326421 **POLLACHI** Coimbatore Steel House Pvt Ltd. q 9451447998 **SALEM** **Bazar Street** National Agencies q 9443367549 • **Subramaniam Street** Eswaran Brothers q 9043657055 **SIVAKASI** M.V.K.D. Thangavelu Nadar q 7339016004 **THENI** VVG Stores q 9965584603 **TIRUNELVELI** T.R. Ponniah Nadar & Son q (046) 22324147 **TIRUPPUR** **Eswaran Koil Street** Karunambika Stores q (0421) 4323747 • **Municipal Office Street** Sree Ramanath Agencies q (0421) 2242870 **TUTICORIN** Ramesh Stores (0461) 2328009

TELANGANA

HANAMKONDA Nandu Enterprises q 9849848177 **HYDERABAD** **Abids** V.G. Enterprises q 9000100495 • **Himayat Nagar** Kundan Stores q (040) 27634010 • **Kondapur** Priya Steel House q 9885998375 • **Kukatpally** Shiv Home World q 9133604440 • Sri Krishna Enterprises q 9246363704 • **Nampally** Steel Palace q 8099850602 • **RP Road** Sana Collections 96

q 9848281566 / (040) 27710840 • **Sanath Nagar** Agro Mech Industries q 9100844451 • **Serilingumpally** Sri Vasavi Steel Palace q 8500284926 **MAHBOOBNAGAR** Hashmi Enterprises q 9642777000 / 9959282297

TRIPURA

AGARTALA **Kaman Chowmohani** Laxmi Bhandar q 9436122355 • **Motor Stand Road** Banty Stores q 9856128296 **DHARMANAGAR** Sathi q 9612473315

UTTAR PRADESH

AGRA **Church Road** V.K. Bartan Bhandar q (0562) 4030978 • **Kaserat Bazar** Agra Bartan Bhandar Pvt. Ltd. q 9837059974 • **Shahganj** Vishal Glass & Crockery Centre q 9634881105 **ALIGARH** **Kanvariganj Road** Madhur Traders q 9719062160 • **Mahavir Ganj** New Jai Deepak Bartan Bhandar q 9927229333 **ALLAHABAD** **Chowk** Gur Prasad Hira Lal q 9839610772 • **Mirza Ghalib Road** Adnan Enterprises q 9936356244 • **Naini** Cooker House q 6392965743 • **Kamla Nehru Road** Novelty House q 9839846880 • The Sair Company q 9839656801 **AZAMGARH** **Jalan** Electricals q 9336381944 **BADAUN** **Dhingra** Crockery House q 6397468402 / 6397475752 **BAHRAICH** Shyamal and Sons q 9793009141 **BALIA** **Murari** Stores q 9721232121 / 9792929202 **BANDA** **Munnu Lal** Bartan Dealer q 7355151552 / 9450168077 **BARAUN** **Nathu Mal** Rakesh Kumar Jain q 9897200811 **BAREILLY** **Civil Lines** **Kumar** Light House q 9259258925 / 9897450973 • **Qila Subzi Mandi** **Giriraj Ji** Bartan Bhandar q 9412446203 **BASTI** **Basti** Light Crockery Centre q 9415193963 **BULANDSHAHR** **Boora Bazar** Raghunath Sahai Nathumal 9837504414 / 9837336664 • **Chowk Bazar** Arora & Sons q 9259341642 **CHIBRAMAU** **Pramod** Kumar Gupta & Sons Bartanwale q 9450694693 **DEORIA** **Rama** Sons q 9415228266 • **Sanjeev** Agencies q 9838864370 **DHAMPUR** **Chhotey Lal** Ashok Kumar q 9411007579 **ETAH** **Loha Mandi** **Etah** Kitchen Corner q 8171192019 • **Post Office Road** **Electric and Music** Corner q 7599470916 **ETAWAH** **Uphar** Kendra q 9412183862 **FAIZABAD** **Awadh** Bartan Bhandar q 9335269434 **FARRUKHABAD** **Pyarey Lal** and Sons q 9415146037 / 6307358657 **FATEHPUR** **Radha** Bartan Bhandar q 8840835656 **GHAZIABAD**

Indirapuram Kusha's Collection q 9910144441 • **Naya Ganj** Chet Ram Dinesh Chand q 9312165172 • **Sihani Gate** U.P. Crockery Store q 9540550894 / 9810660277 • **Vasundhra** Bhagwati Bartan Store q 7838888251 **GHAZIPUR Gandhi Path** Adarsh Bartan Stores q 9415889534 • **Lal Darwaza** Steel Centre q 9415549602 **GONDA** Mishrilal Bartan Bhandar q 9451044804 / 8423110104 **GOPIGANJ** K.K. Traders q 9415375386 **GORAKHPUR Dilezakpur** Durga Bartan Bhandar q 9696460125 • **Golghar** Amar Crockery Centre q 9415067037 • Fine Home Appliances q 9415261999 / 9453040427 • **Hindi Bazar** Sitaram Shyamlal q 9839125555 / 9839125558 • **Reti Chowk** Bharat Trading q 9415210739 • **Town Hall** Shribartan Stores q 7007345149 / 9935544911 • Vijay Agencies q (0551) 2335063 / 7355118364 **HAPUR** Crockery Centre q 9219185330 / 9457075193 **HATHRAS** Ram Saran Lal & Sons q 9412817528 **JAUNPUR** Bharat Glass House q 9696694371 **JHANSI** Nagaria Kitchen Gallery q 9415135768 **KANPUR Bhoosa Toli** Bihari Ji Traders q 9336071941 / 9839605812 • **Halwa Khanda** Shivam Enterprises q 7565826547 • **Lal Bangla** Kitchen Samrat q 9335187817 / 9336101122 • **Sisamau Bazar** Adarsh Kitchen Gallery q 9935564455 • Laxmi Bartan Bhandar q 9453035577 **KERAKAT** Awadh Bartan Bhandar q 9792606368 **KHALILABAD** Mata Prasad Manoj Kumar q 9839382570 **KHATAULI** Chatter Sain Chaman Lal Jain q 9897036715 **KOPAGANJ** Rakesh Kumar Dinesh Kumar q 9838438484 **LAKHIMPURKHERI** B.K. Khanna q 9839965253 **LUCKNOW Alambagh** Om Bartan Bhandar q 9335240170 • **Aminabad** Inder Chand Jain (Bartanwale) q (0522) 24042401 / 9336847600 • **Boothnath Market** Jain Brothers (Bartan Wale) q (0522) 22354520 / 9415108953 • **Gomti Nagar** Puru Traders q 9415470617 • **Hazrat Ganj** Jain Sons q 7839015552 • **Indira Nagar** Kanhaiya Lal Prag Dass (Bartanwale) q 9598050348 • **Nazirabad** Kanhaiya Lal Prag Das q 9532997852 • **Yahiyaganj** Kanhaiya Lal Pragdas (Bartanwale) q 9415108410 • Lala Banwarilal Munna Lal q 9839065921 **MAINPURI** Kunjilal & Sons q 9411014604 **MATHURA** Bhuteshwar Kesari Traders q 8393985555 • **Holi Gate** Dinesh Chandra And Sons q 8439436676 **MEERUT Chowk** Tilakchand Jain & Sons q 9837163505 • **Garh Road** Sharda Kitchen Emporium q 9412707353 • **Khair Nagar** Modern Light House q 8126340422 • **Lala Ka Bazar** Poonam Bartan

Bhandar q 9358985459 **MIRZAPUR Swami Dayanand Marg** New Shyama Crockerries Stores q 9415392336 • **Wellesley Ganj** Krishna Electrical Agency q 9044922292 **MODINAGAR** Singhal Bartan Store q 8218079755 **MORADABAD Bazar Ganj** Bengal Agency q 9927056250 • Crockery Emporium q 9927035618 **MUGALSARAI** Bartan Ghar q 7800347409 **MUNGRA BADSHAHPUR** Shree Ram Enterprises q 9795477245 **MUZAFFARNAGAR** Goel Agencies q (0131) 2623001 / 9568534000 **NOIDA Sector 5** Rajasthan Bartan Store q 9811266805 • **Sector 18** C.S. Electric Company q (0120) 4311055 / 9810278178 • **Sector 27** Super Stores q 9990054644 • **Sector 70** Jindal Crockery q 9810632585 **OBRA** Mai Ram Jai Bhagwan q 9919906061 / 9415679003 **ORAI** Ravi Shankar Navneet Kumar q 9919525721 **PRATAPGARH** Raja Crockery Store q 9580868300 / 9389370078 **RAIBAREILLY** Shubham Bartan Bhandar q 9415190093 **RAMPUR** Mayank Sales q 9837024129 / 9012581327 **SAHARANPUR** Nihal Chand Harbans Lal q 9897607854 • Sajjan & Company q 8267857040 **SAIDPUR** Tribhuwan Prasad and Sons q 9506458080 **SHAMLI** Mittal Crockery q 9837345894 **SITAPUR** Devson Appliances q 9889885955 **SULTANPUR** Ram Sahay Dinesh Prasad q 8299028379 **VARANASI Dal Mandi** Float Glass Emporium q 9415222877 • U.P. Plywood Centre q 9793085786 • **Lahurabir** U.P. Glass Stores q 9473946522 • **Nati Imly** B.K.Traders q 9415353161 • **Sarnath Road** B.K. Bartan Stores q 9795820899 • **Sigra** Girdhar Das & Sons q 8318894257

UTTARAKHAND

ALMORA Anand Emporium q 8449604779 / 9412952275 **BAGESHWAR** Ram Lal Nandan Lal Sah Gangola q 8979356688 **DEHRADUN Ballupur Road** Hulash Raj Associates q 9897898900 • **Dispensary Road** Kanakraj Associates q 7895618194 • Shiv Sagar Home Needs q 9897230035 • **Paltan Bazar** Neeraj Kr. Mayank Kr. Jain q 8979759160 **HALDWANI Karkhana Bazar** Bombay Crockery House q 9917502721 • **Naya Bazar** Luxmi Plastic q 9927966882 **HARIDWAR** Pal Traders q 9319372828 **JWALAPUR Gurudwara Road** Shyam Metals q 9412073661 • **Main Bazar** New Vimal Metals q 9897284101/ 9412073533 **PAURI** Mukesh Taneja Fancy Store q 8126911769 **RISHIKESH Haridwar Road**

Saurabh Traders q 9760993866 • **Kshetra Road** Praveen Enterprises q 9411365087 **ROORKEE Civil Lines** Moradabad House q 9897062828 • **Main Bazar** Marwari Barton Bhandar q 9719585863 **RUDRAPUR** India Industries (Nanak Chand) q 9997088880

WEST BENGAL

ALIPURDUAR Basanti Electric Stores q 9064428815 **ARAMBAGH** Near Girls School New Ramakrishna Basanalaya q 9933065559 • **P.C. Sen Sarani** Jagadhatri Basanalaya q 6296195475 **ASANSOL M.L. Market** Eagle House q 9832122105 / 9800711692 • **Opp. Head Post Office** Sweta Stainless q 7679344421 / 9832816275 **BAHARAMPUR Dr. S.N. Bhattacharjee Road** Koushik Ghosh q 9733923313 • **Near Jal Tank** More Joy Guru Luggage House q 9732515208 / 9932410803 **BALLY** Annapurna Stores q 9836621951 **BALURGHAT** S.Kumar Steel Traders q 9800110006 • **Shree Balaji Steel** q 7278688010 **BANKURA** Joyram Stores q 7001129299 / 9434182975 **BASIRHAT** Suralipi 9733093205 **BELDANGA** Radio Ghar q 9614333427 **BURDWAN** Hindustan Aluminium q 9933036693 / 9932116711 **CHAMPDANGA** Adhikari Variety Stores q 9434486333 **CHANDANNAGAR** Western Trading Co q 9903305293 **CHINSURAH** Mahadeb Kundu & Co q 8777254185 **CONTAI** Sabitri Bhandar q 9609246215 **COOCH BEHAR** Muskan Enterprise q 9474146346 • **Satyanarayan Metal Store** q 9832448884 **DALKHOLA** Mohiuddin Stores q 9733248825 **DIAMOND HARBOUR** Batokrishana Pal & Sons q 9734163234 **DINHATA** Saha Brothers q 9475118237 **DUBRAJPUR** Radha Gopinath Paper House q 9832756657 **DURGAPUR Benachity** Dipty q 6297008059 / 6294185836 • **Chandidas Market** Prince q 9002686449 / 9475241504 • **Hattola Road** Ruj Bros q 9434643472 **FALAKATA** Bhubaneswari Enterprise q 9932460645 **GANGARAMPUR** Transistor House q 9647761355 **GHATAL** Taijaspatra q 9732431588 **HARIPAL** Ratandeep Basanalaya q 9433747352 / 9732427441 **HOWRAH Kadamtala** Grihasthali q 8337091042 • **Mullick Fatak** Howrah Basanalaya q 9830135304 **HRIDAYPUR** Sree Ram Basanalaya q 9830254827 **ISLAMPUR** Islampur Metal Stores q 8617826156 / 9434984157 **JALPAIGURI** Prasadiram Prabhudayal

q 6294584613 **JOYNAGAR** Sree Sree Satyanarayan Bhandar q (03218) 220227 / 9434404016 **KALIYAGANJ** Ashirabad q 9434373897 **KOLKATA Behala** New Behala Steel House q 9836048979 • **Elliot Road** Elkom Enterprises Pvt. Ltd. q 9874206137 • **Garia** New United Sales Emporium q 9831071238 • **Gariahat** New Laxminarayan Bhandar q 9830365724 • **Lal Bazar** Ashoka q 9830540275 • **Old China Bazar Street** Satcowrie Dass & Co q 9831063263 • **Ultadanga** Kitchen Emporium q 9051378731 **KONNAGAR** Grihashree E q 9432872508 **KRISHNANAGAR** Hariom Enterprise q 9002378289 **LALBAG** Step In q 9735430437 **LALGOLA** Rama Basanalaya q 6294891002 **MALBAZAR** Basanalaya q 8918028889 **MALDA** Nataraj Steel Bhandar 9434303949 **MECHEDA** Sankar Basanalay q 8513017842 **MURARAI** Gouranga Dutta q 9732116577 / 8617445781 **NABADWIP** Sahitya Bhavan q 9093279308 **PURULIA** Monika q 9851100950 / 7001132414 **RAGHUNATHGANJ** Prabhat Stores q 9800700108 **RAIGANJ** Bharat Glass Stores q 8100401145 **RAMPURHAT** Dutta Stainless Steel House q 9434142372 / 7797717364 **RANAGHAT** Kalpana Stores q 9734075466 **SAINTHIA** Sarada Basan Stores q 7001950693 / 9475243140 **SANTIPUR** Saha Electric q 9434148572 **SILIGURI** Crockery Palace q 9800279759 • **Nadia** Stores q 9932026652 **SIURI** Tarun Udyog q 7363092093 / 8250070541 **SODEPUR** Narayan Chandra Dey & Co q 9143138985 **TAMLUK** Steel Corner q 9732556135 **TARAKESHWAR** Super Sonic Radio q 9434135831

BHUTAN

PHUNTSHOLING Jain Metal Stores q 9609990903

NEPAL

KATHMANDU Asan Tole Azima Kitchenware q 9851032667 • **Makhan Tole** Sanjay Concern q 9803221834 / 9841476262

INDEX OF RECIPES

	PAGE		PAGE
<i>Aloor Dum</i> (Spicy Potatoes – Bengal Style)	71	<i>Ma ki Dal</i> (Whole Black Gram)	58
<i>Avial</i> (Vegetables in Coconut and Curd – Kerala Style)	67	<i>Mansam Chops</i> (Mutton Chops – Andhra Style)	66
<i>Chana Pindi</i> (Chickpeas – Rawalpindi Style)	60	<i>Matar Paneer</i> (Cottage Cheese and Pea Curry)	59
<i>Chola Dal</i> (Bengal Gram with Coconut)	68	Mixed Vegetable Pulao	74
<i>Elumichham Pazham Saadham</i> (Lime Rice – Tamil Style)	65	<i>Murghi ma Kaju</i> (Chicken with Cashew Nuts – Parsi Style)	77
<i>Gajar ka Halwa</i> (Carrot Pudding)	62	<i>Rajma</i> (Kidney Bean Curry)	61
<i>Illish Sarse Bata</i> (Hilsa Fish in Mustard)	69	<i>Rasogolla</i> (<i>Chhena</i> Balls in Sugar Syrup)	72
<i>Khichuri</i> (Soft Rice with Split Skinned Green Gram and Vegetables)	70	<i>Sambar</i> (Split Skinned Red Gram and Vegetable Curry – Tamil Style)	64
<i>Kozhi Koottaan</i> (Chicken Curry – Kerala Style)	63	<i>Tuvar Dal</i> (Split Skinned Red Gram – Gujarat Style)	75
<i>Lapsi</i> (Sweetened Cracked Wheat)	78	<i>Vatanyachi Usal</i> (White Pea Curry)	76

Space for Your Notes

HAWKINS CLASSIC



**Mixed
Vegetable
Pulao**
in 20 minutes

HAWKINS CONTURA BLACK



Gajar ka Halwa
in 30 minutes

CERAMIC-COATED HAWKINS CONTURA



Avial
in 15 minutes

HAWKINS CONTURA



Chola Dal
in 20 minutes

GUARANTEE
NO.

Hawkins
PRESSURE COOKER

5 Year
Guarantee

Guarantee Card: Terms And Conditions

1. Pressure Cookers are guaranteed for a period of 5 years from the date of first purchase by the user against defects in material and workmanship. **2.** Fair wear and tear is not a defect. Normal replacement parts, namely, safety valve, gasket and plastic handles are not covered under this guarantee. **3.** The complete cooker under complaint must be returned to us or our Authorised Service Centre at the user's cost and this Guarantee Card must be produced along with the cooker. The serial number on the Guarantee Card must match the number on the bottom of the cooker. **4.** The cooker must be used properly in accordance with the printed instructions contained herein. **5.** Genuine parts of our manufacture must be used at all times. **6.** The cooker must not be damaged or weakened by any repair by an unauthorised person. **7.** Subject to the above mentioned terms and conditions, we shall repair or replace free of cost any defective part or parts or the whole cooker at our option.

SOLD BY
Name & Address
of the Dealer
& stamp

Date of Purchase:



Scan to register guarantee
and get more recipes at
www.hawkins.in/recipes

For more recipes and cookbooks in other languages download the [Hawkins Kitchen App](#).

GUARANTEE
NO.

Hawkins
PRESSURE COOKER

5 Year
Guarantee

Guarantee Card: Terms And Conditions

1. Pressure Cookers are guaranteed for a period of 5 years from the date of first purchase by the user against defects in material and workmanship. **2.** Fair wear and tear is not a defect. Normal replacement parts, namely, safety valve, gasket and plastic handles are not covered under this guarantee. **3.** The complete cooker under complaint must be returned to us or our Authorised Service Centre at the user's cost and this Guarantee Card must be produced along with the cooker. The serial number on the Guarantee Card must match the number on the bottom of the cooker. **4.** The cooker must be used properly in accordance with the printed instructions contained herein. **5.** Genuine parts of our manufacture must be used at all times. **6.** The cooker must not be damaged or weakened by any repair by an unauthorised person. **7.** Subject to the above mentioned terms and conditions, we shall repair or replace free of cost any defective part or parts or the whole cooker at our option.

SOLD BY
Name & Address
of the Dealer
& stamp

Date of Purchase:



Scan to register guarantee
and get more recipes at
www.hawkins.in/recipes

For more recipes and cookbooks in other languages download the [Hawkins Kitchen App](#).